

SCTE | **STANDARDS**

Digital Video Subcommittee

SCTE STANDARD

SCTE 35 2023r1

Digital Program Insertion Cueing Message

NOTICE

The Society of Cable Telecommunications Engineers (SCTE) Standards and Operational Practices (hereafter called “documents”) are intended to serve the public interest by providing specifications, test methods and procedures that promote uniformity of product, interoperability, interchangeability, best practices, and the long term reliability of broadband communications facilities. These documents shall not in any way preclude any member or non-member of SCTE from manufacturing or selling products not conforming to such documents, nor shall the existence of such standards preclude their voluntary use by those other than SCTE members.

SCTE assumes no obligations or liability whatsoever to any party who may adopt the documents. Such adopting party assumes all risks associated with adoption of these documents and accepts full responsibility for any damage and/or claims arising from the adoption of such documents.

NOTE: The user’s attention is called to the possibility that compliance with this document may require the use of an invention covered by patent rights. By publication of this document, no position is taken with respect to the validity of any such claim(s) or of any patent rights in connection therewith. If a patent holder has filed a statement of willingness to grant a license under these rights on reasonable and nondiscriminatory terms and conditions to applicants desiring to obtain such a license, then details may be obtained from the standards developer. SCTE shall not be responsible for identifying patents for which a license may be required or for conducting inquiries into the legal validity or scope of those patents that are brought to its attention.

Patent holders who believe that they hold patents which are essential to the implementation of this document have been requested to provide information about those patents and any related licensing terms and conditions. Any such declarations made before or after publication of this document are available on the SCTE web site at <https://scte.org>.

All Rights Reserved
© 2023 Society of Cable Telecommunications Engineers, Inc.
140 Philips Road
Exton, PA 19341

Document Tags

- | | | |
|---|---|--|
| <input checked="" type="checkbox"/> Specification | <input type="checkbox"/> Checklist | <input type="checkbox"/> Facility |
| <input type="checkbox"/> Test or Measurement | <input type="checkbox"/> Metric | <input checked="" type="checkbox"/> Access Network |
| <input checked="" type="checkbox"/> Architecture or Framework | <input checked="" type="checkbox"/> Cloud | <input type="checkbox"/> Customer Premises |
| <input type="checkbox"/> Procedure, Process or Method | | |

Document Release History

Release	Date
SCTE 35 2001	<i>12/14/2001</i>
SCTE 35 2004	<i>5/7/2004</i>
SCTE 35 2007	<i>11/30/2007</i>
SCTE 35 2011	<i>12/5/2011</i>
SCTE 35 2012	<i>8/22/2012</i>
SCTE 35 2013	<i>4/8/2013</i>
SCTE 35 2013a	<i>12/2/2013</i>
SCTE 35 2015	<i>1/5/2015</i>
SCTE 35 2016	<i>3/14/2016</i>
SCTE 35 2017	<i>5/30/2017</i>
SCTE 35 2019	<i>2/11/2019</i>
SCTE 35 2019a	<i>12/16/2019</i>
SCTE 35 2020	<i>12/30/2020</i>
SCTE 35 2022a	<i>7/25/2022</i>
SCTE 35 2022b	<i>9/26/2022</i>
SCTE 35 2023	<i>11/30/2023</i>

Note: Standards that are released multiple times in the same year use: a, b, c, etc. to indicate normative balloted updates and/or r1, r2, r3, etc. to indicate editorial changes to a released document after the year.

Table of Contents

Title	Page Number
NOTICE.....	2
Document Tags.....	3
Document Release History	3
Table of Contents	4
1. Introduction.....	9
1.1. Executive Summary	9
1.2. Scope	9
1.3. Benefits	9
1.4. Intended Audience	10
1.5. Areas for Further Investigation or to be Added in Future Versions.....	10
2. Normative References	10
2.1. SCTE References	10
2.2. Standards from Other Organizations	10
2.3. Published Materials	11
3. Informative References	11
3.1. SCTE References	11
3.2. Standards from Other Organizations	12
3.3. Published Materials	12
4. Compliance Notation	13
5. Abbreviations and Definitions.....	13
5.1. Abbreviations.....	13
5.2. Definitions.....	15
6. Introduction.....	17
6.1. Splice points (Informative).....	17
6.2. Program Splice Points (Informative)	18
6.3. Splice events (Informative).....	19
6.4. Content storage considerations (Informative).....	19
6.5. PID selection	19
6.5.1. PID selection (Normative).....	19
6.5.2. PID selection (Informative).....	20
6.6. Message flow (Informative).....	20
6.7. Usage Examples (Informative).....	22
6.7.1. SCTE 35 Program Content Examples	22
6.7.2. SCTE 35 Ad Break Examples.....	27
7. Notational Conventions	30
7.1. Normative XML schema.....	30
7.1.1. XML namespace and version	31
7.2. Unknown/Unrecognized/Unsupported XML elements and attributes	31
7.3. Element order.....	31
7.4. Binary representation in XML.....	31
8. PMT Descriptors.....	32
8.1. Registration descriptor	32
8.1.1. Semantic definition of fields in Registration Descriptor	33
8.2. Cue Identifier Descriptor	33
8.2.1. Semantic definition of fields in Cue Identifier Descriptor	33
8.2.2. Description of cue_stream_type usage	34
8.3. Stream Identifier Descriptor	34
8.3.1. Semantic definition of fields in Stream Identifier Descriptor	35
9. Splice information table.....	35

9.1.	Overview	35
9.2.	Legacy Command Descriptions	36
9.3.	Time Signal Command.....	36
9.4.	Command Changes	36
9.5.	Time base discontinuities	37
9.6.	Splice info section	37
9.6.1.	Semantic definition of fields in splice_info_section()	40
9.7.	Splice commands.....	43
9.7.1.	splice_null().....	43
9.7.2.	splice_schedule()	44
9.7.2.1.	Semantic definition of fields in splice_schedule()	47
9.7.3.	splice_insert().....	49
9.7.3.1.	Semantic definition of fields in splice_insert().....	51
9.7.4.	time_signal().....	52
9.7.4.1.	Semantic definition of time_signal().....	53
9.7.5.	bandwidth_reservation()	54
9.7.6.	private_command()	54
9.8.	Time	56
9.8.1.	splice_time().....	56
9.8.1.1.	Semantic definition of fields in splice_time().....	56
9.8.2.	break_duration().....	57
9.8.2.1.	Semantic definition of fields in break_duration().....	58
9.9.	Constraints	58
9.9.1.	Constraints on splice_info_section().....	58
9.9.2.	Constraints on the interpretation of time	59
9.9.2.1.	Constraints on splice_time() for splice_insert().....	59
9.9.2.2.	Constraints on break_duration() for splice_insert()	60
9.9.3.	Constraints on Event Id.....	60
10.	Splice Descriptors	61
10.1.	Overview	61
10.2.	Splice descriptor.....	62
10.2.1.	Semantic definition of fields in splice_descriptor().....	62
10.2.2.	Private Splice Descriptors	63
10.3.	Specific splice descriptors	65
10.3.1.	avail_descriptor().....	65
10.3.1.1.	Semantic definition of fields in avail_descriptor()	66
10.3.2.	DTMF_descriptor().....	66
10.3.2.1.	Semantic definition of fields in DTMF_descriptor().....	67
10.3.3.	segmentation_descriptor()	68
10.3.3.1.	Segmentation descriptor details	71
10.3.3.2.	CableLabs metadata identifier	80
10.3.3.3.	MPU() definition and semantics	80
10.3.3.4.	MID() definition and semantics	80
10.3.3.5.	ADS format and definition	81
10.3.3.6.	SCR description and format.....	81
10.3.3.7.	Segmenting Content – Additional semantics	82
10.3.3.8.	Programs - Additional semantics	84
10.3.3.9.	Chapters - Additional semantics	85
10.3.3.10.	Break – Additional semantics.....	86
10.3.3.11.	Delivery Restrictions – Additional semantics	86
10.3.3.12.	Content Identifiers – Additional semantics.....	87
10.3.3.13.	Placement Opportunities – Additional semantics	87
10.3.3.14.	Advertisements, Promos and Ad Blocks – Additional semantics	92
10.3.3.15.	Alternate Content Opportunities – Additional semantics	96
10.3.4.	time_descriptor()	97

10.3.4.1.	Informative description of TAI	97
10.3.4.2.	Semantic definition of fields in time_descriptor()	99
10.3.4.1.	Synchronized Client Clock	100
10.3.4.2.	Synchronized Clock carriage in HLS Timed Metadata (ID3 tags)	101
10.3.5.	audio_descriptor()	102
10.3.5.1.	Semantic definition of fields in audio_descriptor()	103
11.	Encryption	104
11.1.	Overview	104
11.2.	Fixed key encryption	105
11.3.	Encryption algorithms.....	105
11.3.1.	DES – ECB mode	105
11.3.2.	DES – CBC mode	105
11.3.3.	Triple DES EDE3 – ECB mode	106
11.3.4.	User private algorithms	106
12.	SCTE 35 Usage	106
12.1.	SCTE 35 Usage in DASH	106
12.2.	SCTE 35 Usage in HLS	106
12.2.1.	SCTE 35 markup in HLS using EXT-X-DATERANGE.....	107
12.2.2.	SCTE 35 markup in HLS using EXT-X-SCTE35	107
12.2.3.	HLS cue tags.....	107
12.2.4.	HLS playlist example	109
13.	SCTE 35 XML elements and types	110
13.1.	Ext element	110
13.2.	PTSType	111
13.3.	Segmentation Upid Element	111
14.	Sample SCTE 35 Messages (Informative).....	112
14.1.	time_signal – Placement Opportunity Start.....	113
14.2.	splice_insert	114
14.3.	time_signal – Placement Opportunity End.....	115
14.4.	time_signal – Program Start/End	116
14.5.	time_signal – Program Overlap Start.....	117
14.6.	time_signal – Program Blackout Override / Program End	119
14.7.	time_signal – Program End.....	120
14.8.	time_signal – Program Start/End - Placement Opportunity End.....	121

List of Figures

Title	Page Number
Figure 1 - SCTE 35 Program Example	22
Figure 2 - SCTE 35 Program Content Example – Additional Messages	24
Figure 3 - SCTE 35 Program Content Example – Program Control.....	26
Figure 4 - SCTE 35 Ad Break Example	27
Figure 5 - SCTE 35 Advertising Example – Opportunities and Ad Identification.....	30
Figure 6 - SignalGroup.....	32
Figure 7 - SpliceInfoSection	39
Figure 8 - SpliceNull.....	44
Figure 9 - SpliceSchedule	46
Figure 10 - SpliceInsert	50
Figure 11 - TimeSignal.....	53
Figure 12 – BandwidthReservation.....	54

Figure 13 - PrivateCommand	55
Figure 14 - SpliceTime	56
Figure 15 - BreakDuration	57
Figure 16 - SpliceDescriptorType	62
Figure 17 - PrivateDescriptorType	64
Figure 18 - AvailDescriptor	65
Figure 19 - DTMFDescriptor	67
Figure 20 - SegmentationDescriptorType	70
Figure 21 - TimeDescriptor	99
Figure 22 – Time Relationships	101
Figure 23 – AudioDescriptor	103
Figure 24 - Ext Element	111
Figure 25 - SegmentationUpid	112

List of Tables

Title	Page Number
Table 1 - registration_descriptor()	33
Table 2 - cue_identifier_descriptor()	33
Table 3 - cue_stream_type values	34
Table 4 - stream_identifier_descriptor()	35
Table 5 - splice_info_section()	38
Table 6 - sap_type values	40
Table 7 - splice_command_type values	42
Table 8 - splice_null()	43
Table 9 - splice_schedule()	45
Table 10 - splice_insert()	49
Table 11 - time_signal()	53
Table 12 - bandwidth_reservation()	54
Table 13 - private_command()	55
Table 14 - splice_time()	56
Table 15 - break_duration()	57
Table 16 - Splice Descriptor Tags	62
Table 17 - splice_descriptor()	62
Table 18 - avail_descriptor()	65
Table 19 - DTMF_descriptor()	66
Table 20 - segmentation_descriptor()	68
Table 21 - device_restrictions	73
Table 22 - segmentation_upid_type	74
Table 23 - segmentation_type_id	76
Table 24 – MPU()	80
Table 25 – MID()	80
Table 26 – Placement Opportunity Start Numbering Example	90
Table 27 - time_descriptor()	98
Table 28 - audio_descriptor()	102

SCTE 35 2023r1

Table 29 - Encryption algorithm	105
Table 30 - Tag #EXT-X-SCTE35	108
Table 31 - Tag attributes	108

1. Introduction

1.1. Executive Summary

This standard, “Digital Program Insertion Cueing Message for Cable” (SCTE 35), is the core signaling standard for advertising, Program and distribution control (e.g., blackouts) of content for content providers and content distributors. SCTE 35 is being applied to QAM/IP, Title VI/TVE (TV Everywhere), and live/time shifted (DVR, VOD, etc.) delivery. SCTE 35 signals can be used to identify advertising Breaks, advertising content, and programming content (e.g., specific Programs and Chapters within a Program).

SCTE 35 complements other Standards to complete the eco-systems. [SCTE 30] is used to support splicing of advertising into live QAM MPEG-2 transport streams. [SCTE 130-3] is used to support alternate content decisions (advertising, blackouts, stream switching) for live and time shifted delivery. [SCTE 214-1] defines how SCTE 35 is carried in MPEG-DASH. [SCTE 224] (ESNI) is used to pass event and policy information from provider or other systems to communicate distribution control instructions.

The recommended practices for SCTE 35 are contained in [SCTE 67] “Recommended Practice for Digital Program Insertion for Cable”.

1.2. Scope

This standard supports delivery of events, frame accurate or non-frame accurate, and associated descriptive data in MPEG-2 transport streams, MPEG-DASH and HLS. This standard supports the splicing of content (MPEG-2 transport streams, MPEG-DASH, etc.) for the purpose of Digital Program Insertion, which includes Advertisement insertion and insertion of other content types. This standard defines an in-stream messaging mechanism to signal splicing and insertion opportunities. As such, this standard does not specify the insertion method used or constraints applied to the content being inserted, nor does it address constraints placed on insertion devices.

Fully compliant MPEG-2 transport stream (either Multi Program Transport Stream or Single Program Transport Stream), MPEG-DASH content, etc. is assumed. No further constraints beyond the inclusion of the defined cueing messages are placed upon the stream.

This standard specifies a technique for carrying notification of upcoming points and other timing information in the transport stream. A splice information table is defined for notifying downstream devices of splice events, such as a network Break or return from a network Break. For MPEG-2 transport streams, the splice information table, which pertains to a given program, is carried in one or more MPEG Sections carried in PID(s) referred to by that program’s Program Map Table (PMT). In this way, splice event notification can pass through most transport stream remultiplexers without need for special processing. For MPEG-DASH, the splice information table is carried in the DASH MPD (See [SCTE 214-1]) or in media segments (see [SCTE 214-2] and [SCTE 214-3]). Section 12.2 details how SCTE 35 messages are carried in HLS manifests.

1.3. Benefits

SCTE 35 is a key part of the eco-system to enable advertising and content distribution business. A common/well-formed signaling model enables downstream systems to be implemented in a cost effective, consistent and non-ambiguous fashion to achieve business objectives.

1.4. Intended Audience

The intended audience is content providers, multi-channel video program distributors, TV everywhere providers/distributors and vendors/developers who build solutions.

1.5. Areas for Further Investigation or to be Added in Future Versions

Follow-up work related to UHD and HDR *may* be addressed. The use of studio time is currently an active topic in the DASH-IF group and a future version of this standard *may* want to reference that work. Sections 10.3.3.5 to 10.3.3.12 *should* be reviewed.

2. Normative References

The following documents contain provisions which, through reference in this text, constitute provisions of this document. The editions indicated were valid at the time of subcommittee approval. All documents are subject to revision and, while parties to any agreement based on this document are encouraged to investigate the possibility of applying the most recent editions of the documents listed below, they are reminded that newer editions of those documents might not be compatible with the referenced version.

2.1. SCTE References

- No normative references are applicable.

2.2. Standards from Other Organizations

[ATSC A/57B]	ATSC A/57B – ATSC Standard: Content Identification and Labeling for ATSC Transport Document A/57B, 26 May 2008
[ATSC A/52]	A/52:2018: Digital Audio Compression (AC-3) (E-AC-3) Standard
[CLADI1-1]	MD-SP-VOD-CONTENTv1.1 – C01-120803 – CableLabs Video-on-Demand Content Specification 1.1
[EIDR ID FORMAT]	EIDR ID Format – “EIDR: ID FORMAT Ver. 1.5.1 5 Oct 2017
[FIPS PUB 46-3]	FIPS PUB 46-3, 1999 October 25 – Data Encryption Standard
[FIPS PUB 81]	FIPS PUB 81, 1980 December 2 – DES Modes of Operation
[HLS]	RFC 8216 – “HTTP Live Streaming”
[ISO/BMFF]	ISO/IEC 14496-12:2020 Information technology - Coding of audio-visual objects - Part 12: ISO base media file format
[ISO 15706-2]	ISO 15706-2:2007 – Information and Documentation – International Standard Audiovisual Number (V-ISAN) – Part 2: Version Identifier
[ISO 639-2]	Codes for the Representation of Names of Languages
[MPEG Systems]	ITU-T Recommendation H.222.0 / ISO/IEC 13818-1 (2019) – Information Technology – Generic Coding of Moving Pictures and Associated Audio Information: Systems
[RFC 3986]	RFC 3986 – “Uniform Resource Identifier (URI): Generic Syntax”, January 2005
[RFC 4122]	RFC 4122 – “A Universally Unique Identifier (UUID) URN Namespace”, July 2005
[RFC 4648]	RFC 4648 – “The Base16, Base32, and Base64 Data Encodings”
[RFC 5646]	RFC 5646 – “Tags for Identifying Languages”
[SMPTE 330]	SMPTE ST 330:2011 Unique Material Identifier (UMID)

[XML]	W3C Recommendation, “Extensible Markup Language (XML) 1.0 (Fifth Edition)”
[XML Namespaces]	W3C Recommendation, “Namespaces In XML (Third Edition)”
[XML InfoSet]	W3C Recommendation, “XML InfoSet (Second Edition)”, John Cowan
[XML SchemaP1]	W3C Recommendation, “XML Schema Part 1: Structures (Second Edition)”, H. Thompson, et al, 28 October 2004
[XML SchemaP2]	W3C Recommendation, “XML Schema Part 2: Datatypes (Second Edition)”, P. Biron, et al, 28 October 2004

2.3. Published Materials

- No normative references are applicable.

3. Informative References

The following documents might provide valuable information to the reader but are not required when complying with this document.

3.1. SCTE References

[SCTE 30]	SCTE 30– Digital Program Insertion Splicing API
[SCTE 67]	SCTE 67– Recommended Practice for Digital Program Insertion for Cable
[SCTE 104]	SCTE 104– Automation System to Compression System Communications Applications Program Interface (API)
[SCTE 118-2]	SCTE 118-2– Program-Specific Ad Insertion – Content Provider to Traffic Communication Applications Data Model
[SCTE 130-3]	SCTE 130-3– Digital Program Insertion-Advertising Systems Interfaces – Part 3 – Ad Management Service (ADM) Interface
[SCTE 172]	SCTE 172– Constraints on AVC and HEVC Structured Video Coding for Digital Program Insertion
[SCTE 214-1]	SCTE 214-1– MPEG DASH for IP-Based Cable Services Part 1: MPD Constraints and Extensions
[SCTE 214-2]	SCTE 214-2– MPEG DASH for IP-Based Cable Services Part 2: DASH/TS Profile
[SCTE 214-3]	SCTE 214-3 MPEG DASH for IP-Based Cable Services Part 3: DASH/FF Profile
[SCTE 223]	SCTE 223 – Adaptive Transport Stream
[SCTE 224]	SCTE 224 – Event Scheduling and Notification Interface
[SCTE 236]	SCTE 236 – Content Metadata ¹
[SCTE 248]	Operational Practice on Multiple Audio Signaling
[SCTE 250]	Event and Signaling Management API (ESAM)

¹ Formerly CableLabs Content 3.0

3.2. Standards from Other Organizations

[Ad-ID]	Advertising Digital Identification, LLC
[DASH]	ISO/IEC 23009-1 Information technology – Dynamic adaptive streaming over HTTP (DASH) – Part 1: Media presentation description and segment formats
[DOI]	Digital Object Identifier
[EIDR]	Entertainment ID Registry Association (EIDR)
[ETSI 103 752-1]	ETSI TS 103 752-1 – Dynamic substitution of content in linear broadcast; Part 1: Carriage and signaling of placement opportunity information in DVB Transport Streams
[HLS-TMD]	Timed Metadata for HTTP Live Streaming
[ID3v2-struct]	ID3 Tag version 2.4.0 – Main Structure
[ISAN]	ISAN (International Standard Audiovisual Number) website
[ISO 13818-4]	ISO/IEC 13818-4 – Information Technology – Generic coding of moving pictures and associated audio information – Part 4: Conformance testing
[ISO 15706-1]	ISO 15706-1 – Information and Documentation – International Standard Audiovisual Number (ISAN)
[ISO 15706-1 Amd 1]	ISO 15706-1 Amd 1 – Alternate Encodings and editorial changes
[ITU H.262]	ITU-T Recommendation H.262 / ISO/IEC 13818-2 (2000), Information Technology – Generic Coding of Moving Pictures and Associated Audio Information: Video
[PTP]	IEEE 1588-2008, IEEE, 24 July 2008, doi:10.1109/IEEESTD.2008.4579760
[RFC5905]	“Network Time Protocol Version 4: Protocol and Algorithms Specification”
[SMPTE 312]	SMPTE ST 312:2001 – SMPTE STANDARD for Television – Splice Points for MPEG-2 Transport Streams
[SMPTE 2092-1]	SMPTE RP 2092-1:2015 – SMPTE Recommended Practice, Advertising Digital Identifier (Ad-ID(R)) Representations
[SMPTE 2079]	SMPTE RP 2079:2013 – Digital Object Identifier (DOI) Name and Entertainment ID Registry (EIDR) Identifier Representations
[SMPTE RA]	SMPTE Registration Authority, LLC

3.3. Published Materials

[ETDS]	Media Perspectives Event Triggering Distribution Specification (ETDS) and Event Triggering Distribution Specification Supplement (ETDSS)
--------	--

4. Compliance Notation

<i>shall</i>	This word or the adjective “ <i>required</i> ” means that the item is an absolute requirement of this document.
<i>shall not</i>	This phrase means that the item is an absolute prohibition of this document.
<i>forbidden</i>	This word means the value specified <i>shall</i> never be used.
<i>should</i>	This word or the adjective “ <i>recommended</i> ” means that there <i>may</i> exist valid reasons in particular circumstances to ignore this item, but the full implications <i>should</i> be understood and the case carefully weighed before choosing a different course.
<i>should not</i>	This phrase means that there <i>may</i> exist valid reasons in particular circumstances when the listed behavior is acceptable or even useful, but the full implications <i>should</i> be understood and the case carefully weighed before implementing any behavior described with this label.
<i>may</i>	This word or the adjective “ <i>optional</i> ” indicate a course of action permissible within the limits of the document.
deprecated	Use is permissible for legacy purposes only. Deprecated features <i>may</i> be removed from future versions of this document. Implementations <i>should</i> avoid use of deprecated features.

NOTE: Where a feature is *deprecated* in the standard:

1. Related text will be grayed out. (Ex. For Component Splice Mode ...).
2. For figures containing XML Schemas there will be an informative note.

5. Abbreviations and Definitions

5.1. Abbreviations

AC-3	Audio Codec 3 (also known as Dolby Digital)
ADI	Asset Distribution Interface
ADM	Ad Management Service
Ad-ID	Advertisement Identifier
API	Application Programming Interface
ATSC	Advanced Television Systems Committee.
AVC	Advanced Video Coding
bslbf	Bit string, left bit first, where left is the order in which bit strings are written.
CBC	Cipher Block Chaining
CRC	Cyclic Redundancy Check
DASH	Dynamic Adaptive Streaming over HTTP
DASH-IF	DASH Industry Forum
DES	Data Encryption Standard
DOI	Digital Object Identifier
DTMF	Dual Tone Multi Frequency
DTS	Decoding Time Stamp
DVB	Digital Video Broadcasting
E-AC-3	Enhanced Audio Codec 3 (also known as Dolby Digital Plus)
ECB	Electronic CodeBook
EIDR	Entertainment Identifier Registry

ESAM	Event Signaling and Management API
FIPS	Federal Information Processing Standard
GPS	Global Positioning System
GUID	Globally Unique Identifier (see [RFC 4122]).
HEVC	High Efficiency Video Coding
HLS	HTTP Live Streaming
HTTP	HyperText Transfer Protocol
IEC	International Electro-technical Commission
IEEE	Institute of Electrical and Electronics Engineers
ISAN	International Standard Audiovisual Number (see [ISO 15706-1] and [ISO 15706-1 Amd 1])
ISCI	Industry Standard Commercial Identifier
ISO	International Organization for Standardization
IP	Internet Protocol
ITU-T	International Telecommunication Union Telecommunications sector
MID	Multiple UPID
MPEG	Moving Picture Experts Group
MPD	Media Presentation Description
MPTS	a Multi Program Transport Stream.
MPU	Managed Private UPID
MVPD	Multi-Channel Video Program Distributors; also cited as “content distributor”, “distributor”, or affiliate.
NTP	Network Time Protocol as defined in IETF [RFC5905].
PCR	Program Clock Reference
PID	Packet Identifier; a unique 13-bit value used to identify the type of data stored in the packet payload (see [MPEG Systems]).
PMT	Program Map Table (see [MPEG Systems]).
PTP	Precision Time Protocol as defined in IEEE Std 1588-2008 PTP.
PTS	Presentation Time Stamp (see [MPEG Systems]).
Rpchof	Remainder polynomial coefficients, highest order first.
RFC	Request for Comments
SAP	Stream Access Point (see [ISOBMFF])
SCTE	Society of Cable Telecommunications Engineers
SMPTE	Society of Motion Picture and Television Engineers
SPTS	a Single Program Transport Stream.
STC	System Time Clock
TAI	International Atomic Time (TAI, from the French name Temps Atomique International) This time reference scale was established by the BIPM (Bureau International des Poids et Mesures) on the basis of atomic clock readings from various laboratories around the world.
TI	Turner Identifier
TID	Tribune Identifier
TS	Transport Stream
uimsbf	Unsigned integer, most significant bit first.
UMID	Unique Material Identifier
UPID	Unique Program Identifier
URI	Uniform Resource Identifier – See [RFC 3986].
UTC	Coordinated Universal Time. This is the primary time standard by which the world regulates clocks and time.

UUID	Universally Unique Identifier
V-ISAN	Version-ISAN (core ISAN number plus a version number) – See [ISO 15706-2]).
XML	Extensible Markup Language – See [W3C Recommendation, “Extensible Markup Language (XML) 1.0]
W3C	World Wide Web Consortium

5.2. Definitions

Definitions of terms used in this document are provided in this section. Defined terms that have specific meanings are capitalized. When the capitalized term is used in this document, the term has the specific meaning as defined in this section.

Access Unit	A coded representation of a presentation unit (see [ITU H.262]).
Alternate Content Opportunity	A potentially constrained location relative to digital content where Program based content alterations can occur. The alterations may include insertions, replacements, or deletions of Program based content in whole or in part (e.g., one or more Chapters with or without Breaks).
Advertisement (also called “ad”)	An inducement to buy or patronize. As used in the cable industry, usually with a duration under 2 minutes (sometimes called “short-form” content).
Ad Block	A potentially constrained location relative to digital content where Ad based content alterations can occur within a Placement Opportunity. The location is constrained as a particular selection of contiguously scheduled Ads so that the sum of their durations is available for insertion or modification rather than each Ad’s individual duration.
Analog Cue Tone	In an analog system, a signal that is usually either a sequence of DTMF tones or a contact closure that denotes to ad insertion equipment that an Advertisement avail is about to begin or end.
Avail	Time space provided to cable operators by cable programming services during a Program for use by the MVPD operator; the time is usually sold to local advertisers or used for channel self-promotion.
Barter Ad	Advertisement media incorporated into program content that shall be distributed according to the carriage and or licensing agreement for that program.
Bit Stream Format	An encoding of information resulting in a compliant MPEG-2 transport stream. See [MPEG Systems].
Break	Avail or actual insertion in progress. In a sales context, a Break is divided into sellable units (Avails). In an insertion context, a Break is divisible into individual insertion events (slots). Also, a SCTE 35 Segmentation Type, “Break Start/End” that is typically used to mark all non-program sections. These would include promotional material and advertisements including barter ads.
Chapter	A short section of a longer Program, usually situated to permit a viewer to easily locate a scene or section of the Program.
Component Splice Mode (Deprecated)	A mode of the cueing message whereby the program_splice_flag is set to ‘0’, indicating that each PID/component that is intended to be spliced will be listed separately by the syntax that follows. Components not listed in the message are not to be spliced.

Content	Generic term for television material, either Advertisements or Programs.
Content Distributor	Typically an MVPD; also cited as “distributor”.
Content Provider	Typically a network programmer; also cited as “programmer” or “provider”.
Cueing Message	See message.
Cue Stream	A PID stream that contains cue messages.
Event	A splice event or a viewing event.
In Point	A point in the stream, suitable for entry, that lies on an elementary Presentation Unit boundary. The In Point is the first Presentation Unit in the bit stream with a time greater than or equal to the In Point time.
In Stream Device	A device that receives the transport stream directly and is able to derive timing information directly from the transport stream.
Message	In the context of this document a message is the content of any splice_info_section.
Multi Program Transport Stream	A transport stream with multiple programs.
Out-of-Stream Device	A device that receives the cue message from an in-stream device over a separate connection from the transport stream. An out-of-stream device does not receive or pass the transport stream directly.
Out Point	A point in the stream, suitable for exit, that lies on an elementary Presentation Unit boundary. The Out Point is before the first Presentation Unit in the bit stream with a time greater than or equal to the Out Point time.
payload_unit_start_indicator	A bit in the transport packet header that signals, among other things, that a section begins in the payload that follows (see [MPEG Systems]).
Placement Opportunity	A potentially constrained location relative to digital content where ad insertion or content alterations can occur. The alterations may include insertions, replacements, or deletions of content in whole or in part. These locations, which contain the opportunity for content insertion, have traditionally been referred to as Avails [SCTE35] for linear video content; however, Placement Opportunity refers to address and time locations where content may be placed, regardless of platform (i.e. Video in VOD, Banner Images on Menus and ITV channels, etc.).
PID stream	All the packets with the same PID within a transport stream.
pointer_field	The first byte of a transport packet payload, required when a section begins in that packet (see [MPEG Systems]).
Presentation Time	The time that a presentation unit is presented in the system target decoder (see [MPEG Systems]).
Presentation Unit	A decoded Audio Access Unit or a decoded picture (see [ITU H.262]).
Program	A collection of video, audio, and data PID streams that share a common program number within an MPTS (see [MPEG Systems]). As used in the context of the segmentation descriptor, a performance or informative presentation broadcast on television, typically with a duration over 5 minutes (sometimes called “long-form” content).
Program In Point	A group of PID stream In Points that correspond in presentation time.
Program Out Point	A group of PID stream Out Points that correspond in presentation time.

Program Splice Mode	A mode of the cueing message whereby the <code>program_splice_flag</code> is set to '1', indicating that the message refers to a Program Splice Point and that all PIDs/components of the program are to be spliced.
Program Splice Point	A Program In Point or a Program Out Point.
Promo	An individual, self-contained audio-visual non-merchandisable or promotional item. If a content provider does not support dedicated identification of Promos, these Segments can be signaled as Advertisements
Receiving Device	A device that receives or interprets sections conforming to this standard. Examples of these devices include splicers, ad servers, segmenters and satellite receivers.
Registration Descriptor	Carried in the PMT of a program to indicate that, when signaling splice events, <code>splice_info_sections</code> shall be carried in a PID stream within this program. The presence of the Registration Descriptor signifies a program's compliance with this standard.
reserved	The term "reserved", when used in the clauses defining the coded bit stream, indicates that the value <i>may</i> be used in the future for extensions to the standard. Unless otherwise specified, all reserved bits shall be set to '1' and this field shall be ignored by receiving equipment.
Segment	A Segment can refer to Content, Advertising, Alternate Content or others. See Table 23, <code>segmentation_type_id</code> , for full list of segment types.
Single Program Transport Stream	A transport stream containing a single MPEG program.
Splice Event	An opportunity to splice one or more PID streams.
Splice Immediate Mode	A mode of the cueing message whereby the splicing device shall choose the nearest opportunity in the stream, relative to the <code>splice_info_table</code> , to splice. When not in this mode, the message gives a "pts_time" that, when modified by <code>pts_adjustment</code> , gives a presentation time for the intended splicing moment.
Splice Point	A point in a PID stream that is either an Out Point or an In Point.
Sub-segment	A sub-segment is subset of a segment. See Table 23 for <code>segmentation_type_id</code> that can include sub-segment information.
UPID	Identifier for the content or content Segment that programmers' systems utilize.
Viewing Event	A television Program or a span of compressed material within a service; as opposed to a splice event, which is a point in time.

6. Introduction

6.1. Splice points (Informative)

To enable the splicing of compressed bit streams, this standard defines Splice Points. Splice Points in an MPEG-2 transport stream provide opportunities to switch elementary streams from one source to another. They indicate a place to switch or a place in the bit stream where a switch can be made. Splicing at such Splice Points *may* or *may not* result in good visual and audio quality. That is determined by the performance of the splicing device.

The use of “advanced” video compression, such as documented by ITU-T H.264/ ISO/IEC 14496-10 (“AVC”) or ITU-T H.265/ ISO/IEC 23008-2 (“HEVC”) typically requires advance notice of Splice Points to permit the video encoder to create a spliceable point in the video elementary stream. In most systems this is provided by the use of [SCTE 104] to provide a communications path from the programmer’s Automation System to their Compression System. These AVC and HEVC coding constraints for Splice Points are documented in [SCTE 172].

Transport streams are created by multiplexing PID streams. In this standard, two types of Splice Points for PID streams are defined: Out Points and In Points. In Points are places in the bit streams where it is acceptable to enter, from a splicing standpoint. Out Points are places where it is acceptable to exit the bit stream. The grouping of In Points of individual PID streams into Program In Points in order to enable the switching of entire Programs (video with audio) is defined. Program Out Points for exiting a Program are also defined.

Out Points and In Points are imaginary points in the bit stream. The Out Point or In Point is the first Presentation Unit in the bit stream with a time greater than or equal to the Out Point time or In Point time respectively. Out Points and In Points are not necessarily transport packet aligned and are not necessarily PES packet aligned. An Out Point and an In Point *may* be co-located; that is, a single presentation unit boundary *may* serve as both a safe place to leave a bit stream and a safe place to enter it.

The output of a switching operation from one stream to another stream will contain access unit data from one stream up until its Out Point followed by data from another stream starting with the first access unit following an In Point. More complex splicing operations *may* exist whereby data prior to an Out Point or data after an In Point are modified by a splicing device. Splicing devices *may* also insert data between one stream’s Out Point and the other stream’s In Point. The behavior of splicing devices will not be specified or constrained in any way by this standard.

6.2. Program Splice Points (Informative)

Program In Points and Program Out Points are sets of PID stream In Points or Out Points that correspond in presentation time.

Although Splice Points in a Program Splice Point correspond in presentation time, they do not usually appear near each other in the transport stream. Because compressed video takes much longer to decode than audio, the audio Splice Points *may* lag the video Splice Points by as much as hundreds of milliseconds and by an amount that can vary during a Program.

This standard defines two ways of signaling which Splice Points within a program are to be spliced. A `program_splice_flag`, when true (set to a value of “1”), denotes that the Program Splice Mode is active and that all PIDs of a program *may* be spliced (the splice information table PID is an exception; splicing or passage of these messages is beyond the scope of this standard).

Component Splice Mode is *deprecated*.

A `program_splice_flag`, when false (set to a value of “0”), indicates that the Component Splice Mode is active and that the message will specify unambiguously which PIDs are to be spliced and *may* give a unique splice time for each. This is required to direct the splicing device to splice or not to splice various unspecified data types as well as video and audio.

While this standard allows for a unique splice time to be given for each component of a program, it is expected that most Component Splice Mode messages will utilize one splice time (a default splice time) for all components as described in Section 9. The facility for optionally specifying a separate splice time for each component is intended to be used when one or more components differ significantly in their start

or stop time relative to other components within the same message. An example would be a downloaded applet that must arrive at a set-top box several seconds prior to an Advertisement.

6.3. Splice events (Informative)

This standard provides a method for in-band signaling of splice events using splice commands (ex. splice_insert or time_signal with relevant descriptor) to downstream splicing equipment. Signaling a splice event identifies which Splice Point within a stream to use for a splice. A splicing device *may* choose to act or not act upon a signaled event (a signaled event *should* be interpreted as an opportunity to splice; not a command). A splice information table carries the notice of splice event opportunities. Each signaled splice event is analogous to an analog cue tone. The splice information table incorporates the functionality of cue tones and extends it to enable the scheduling of splice events in advance.

This standard establishes that the splice information table is carried on a per-program basis in one or more PID stream(s) with a designated stream_type. The program's splice information PID(s) are designated in the program's Program Map Table (PMT). In this way, the splice information table is switched with the program as it goes through remultiplexing operations. A common stream_type identifies all PID streams that carry splice information tables. Remultiplexers or splicers *may* use this stream_type field to drop splice information prior to sending the transport stream to the end-user device.

The cue injection equipment *may* send messages at intervals that do not indicate a Splice Point to be used as heartbeat messages which help ensure the proper operation of the system. This could be performed by periodically issuing splice_null() messages or by sending encrypted splice_insert() or time_signal() message generated with a key that is not distributed. Since cues are currently sent twice per hour on a typical network, an average interval of 5 minutes would be a reasonable interval. If a message was not received in a 10-minute interval, a receiving device could alarm an operator to a possible system malfunction (such behavior would be implementer dependent).

6.4. Content storage considerations (Informative)

The requirements for identifier uniqueness are written expecting the content to be playing in real time. If the content is stored, then the playback of the content does not place requirements upon the playback equipment to alter any of these identifiers (such as splice_event_id or segmentation_event_id). Downstream equipment parsing the identifiers *should* keep this in mind and, if applicable, rely upon other confirming information before reacting adversely to a seeming violation of the identifier uniqueness requirements of this standard.

This standard provides optional tools to assist with segmenting content into shorter sections which *may* be either Chapters or Advertisements (see Section 10.3.3).

6.5. PID selection

6.5.1. PID selection (Normative)

Splice Information can be carried in multiple PIDs. The maximum number of PIDs that can carry splice information *shall not* exceed 8. These PIDs can be either in the clear (where the transport scrambling_control bits are set to '00') or scrambled by a CA system. Each cue message PID *may* include the cue_identifier_descriptor defined in Section 8.2 to describe the splice commands included in the PID. When multiple PIDs are used to carry splice information, the first cue message PID in the Program Map Table *shall* only contain the splice command types 0x00 (splice_null), 0x04 (splice_schedule) and 0x05 (splice_insert). In addition, the splice_event_id *shall* be unique in all splice information PIDs within the program.

6.5.2. PID selection (Informative)

While the use of multiple cue message PIDs is an allowed practice, it *should* be noted that not all equipment *may* respond in the same manner to a stream that contains multiple cue message PIDs. Some equipment *may* limit the number of PIDs that the equipment can pass or receive. If a system utilizes multiple PIDs through various devices with the intention of reaching the set-top, it is suggested that thorough end-to-end testing be performed.

In many systems, the delivery of PIDs that carry splice information beyond the ad insertion equipment in the head-end is not desired. In these systems, the splicing or multiplexing device will drop any or all of these messages (PIDs), so they will not be delivered to the set-top. In other systems, it *may* selectively pass certain PIDs to enable set-top functionality. A third possibility is that the splicing or multiplexing device will aggregate the multiple PIDs that carry splice information into a single PID to handle downstream (set-top) issues with multiple PIDs. The action of ignoring or passing the message is recommended to be a user provisioned item, with a suitable default behavior chosen by the implementer.

The default operation if a splicing or multiplexing device receives a PID based on this specification with the scrambling bits set in the header *should* be to drop that PID and not pass it through to the output. This ideally *should* be a user provisioned operation, as in some instances this PID *may* be descrambled by a downstream device.

The delivery of messages outside of the receive location to the customer *may* be based on business agreements. An example would be that one programmer wants the cue messages passed to set-tops to enable a targeted advertising method while a different programmer insists that the messages be dropped to ensure that a commercial killer *may* not utilize the messages.

When multiple splicing PIDs are identified in the PMT, the splicing device *should* process all of these PIDs. If the cue_identifier_descriptor is utilized, the splicing or multiplexing device *may* use that information to be more selective of the PIDs on which it will act.

Some possible reasons for utilizing multiple PIDs for this message include selective delivery of cue messages for different tiers of advertising or for separating cue messages from segmentation messages. While one possible method of handling these issues is to use the encryption methods built into this standard, many delivery mechanisms can support conditional delivery by PID in a secure fashion. The delivery equipment (satellite transmitter/receiver, remultiplexer) *may* PID filter the stream to only allow one or a small number of the PIDs to be passed in-stream. This method *may* be used to create multiple programs in the feed based on entitlement. The decision to use one or more PIDs will be based on the security required and the CA hardware available on the system.

6.6. Message flow (Informative)

The messages described in this document can originate from multiple sources. They are designed to be sent in-stream to downstream devices. The downstream devices *may* act on the messages or send them to a device that is not in-stream to act upon them. An example would be a splicer communicating via SCTE 30 protocol to an ad server (See [SCTE 30]). The in-stream devices could pass the messages to the next device in the transmission chain, or they could, optionally, drop the messages. Implementers are urged to make these decisions user provisioned, rather than arbitrarily hard-coded.

Any device that re-stamps PCR/PTS/DTS and that passes these cue messages to a downstream device *should* modify the pts_time field or the pts_adjustment field in the message in all PIDs conforming to this standard. Modifying the pts_adjustment field is preferred because the restamping device will not have to

be knowledgeable of the pts_time field that *may* occur in multiple commands (and possibly in future commands).

The bandwidth_reservation() message is intended as a message used on a closed path from an origination system (encoder) to a receiver. It is also intended that this message will be dropped (replaced by a NULL packet) by the receiver, but this is not required. *Should* this message reach an in-stream device (e.g., a splicer) the message *should not* be forwarded to an out-of-stream device (e.g., Ad Server) and can either be ignored or passed by an in-stream device. The action of ignoring or passing the message is recommended to be a user provisioned item, with a suitable default behavior chosen by the implementer.

6.7. Usage Examples (Informative)

The following sections are examples on the usage of SCTE 35 for marking various Program and Advertisement Segments. The various SCTE 35 Cueing Messages are typically placed in affiliate programming tiers by the programmer, so an affiliate will only see the cues for which they are authorized. See Section 14 for sample SCTE 35 Messages.

Normative constraints on Content and Advertising Segments can be found in Section 10.3.3.7.

6.7.1. SCTE 35 Program Content Examples

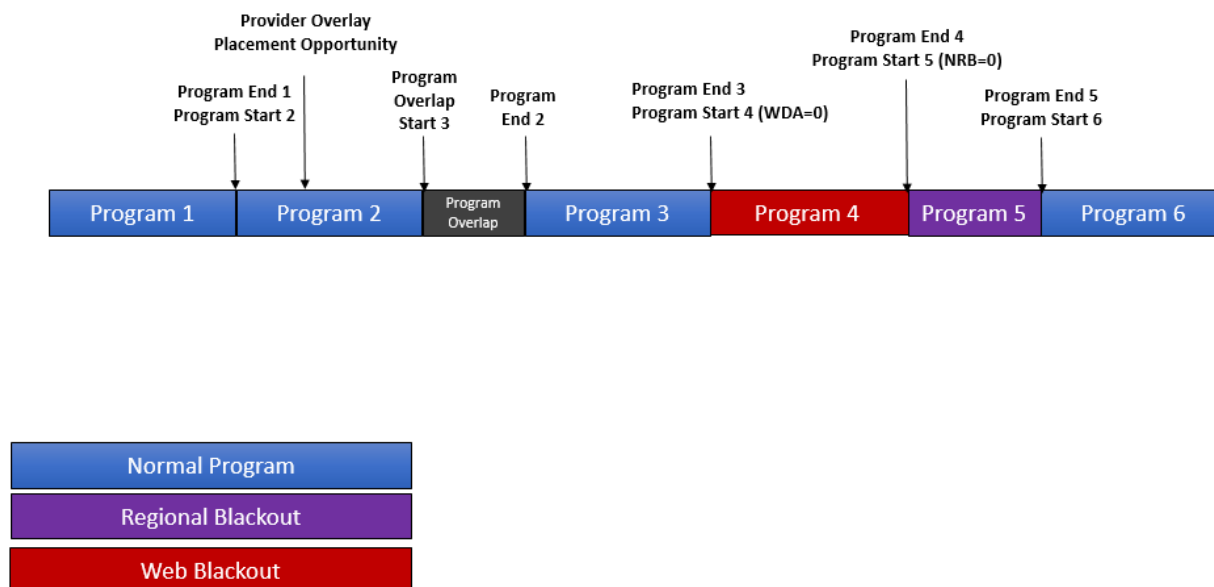

Figure 1 - SCTE 35 Program Example

Ad Breaks described in section 6.7.2 are typically embedded at various points within the Program content; they are not shown in this diagram.

Figure 1 shows the segmentation types used to delineate common programming sequences. The programmer should set the segmentation Unique Program Identifier (UPID) to a value that can be cross referenced to the SCTE 224 feed in order to deliver additional information about the Program.

WDA is the Web Delivery Allowed flag [see Section 10.3.3]. Setting this to false (0) indicates that there is a web blackout. An implementer would need to verify exactly what the programmer means by this, but it is typically used to indicate anything delivered to a subscriber over the open internet as opposed to a closed MVPD network.

NRB is the No Regional Blackout flag [see Section 10.3.3]. When set to false (0), this indicates that this Program is subject to a regional blackout. An implementer would, likely, refer to a SCTE 224 feed or a programmer or sports league website to determine the appropriate blackout geography.

Figure 2 illustrates basic Program Content Segment elements including Network, Program and Chapter. Additionally, the figure calls out Alternate Content, Program Immediate Resumption and how

Advertising Segments can be defined using SCTE 35 messages. Alternate Content and Program Immediate handling within the Distributor ecosystem is dictated by external metadata (ex. SCTE 224) or system configuration. Advertising Segments can be defined within Chapters or between Chapters.

Time	Description
t1	Start messages are sent initiating the Network, Program, Alternate Content and Chapter.
t2	Indicates start of advertising related messages within a Chapter. See Sections 6.7.2 and 6.7.2 for examples of advertising related messages. If the Provider wants to signal a return to primary programming during processing of advertising related messages a “Program Immediate Resumption” can be sent. If Alternate Content is being presented there will be no change to the content presented.
t3	Indicates end of advertising related messages within a Chapter.
t4	Similar to t2 above except “Program Immediate Resumption” is indicated for both primary programming and alternate content.
t5	Similar to t3 above.
t6	Indicates end of Chapter 1 and start of Chapter 2.
t7	Indicates end of Chapter 2. Also indicates start of advertising related messages outside of a Chapter. If the Provider wants to signal a return to primary programming during processing of advertising related messages a “Program Immediate Resumption” can be sent.
t8	Indicates end of advertising related messages outside of a Chapter. Also indicates the start of another set of advertising related messages.
t9	End of advertising related messages outside of a chapter. Also indicates the start of an Alternate Content Opportunity.
t11	Indicates start of Chapter 3.
t12	Indicates end of Program, Alternate Content and Chapter.

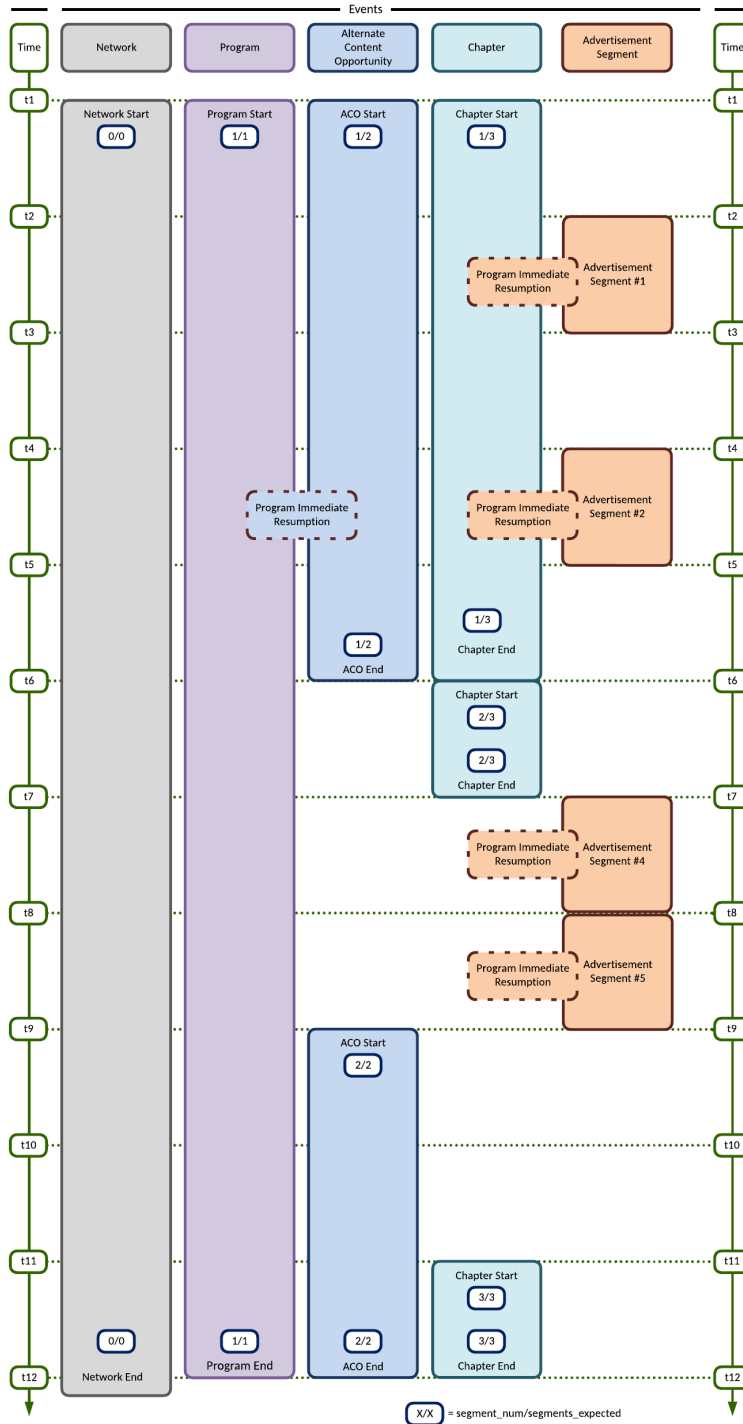

Figure 2 - SCTE 35 Program Content Example – Additional Messages

Figure 3 illustrates Program Content Segmentation use cases specific to Program Breakaway/Resumption and Program Overlaps. On a Program Breakaway if a Chapter is active for the Program, the Chapter will also be suspended. On Program Resumption, in addition to the Program, the Chapter will be resumed.

Time	Description
t1	Indicates the start of a program and chapter.
t4	Indicates an explicit program breakaway with implicit chapter breakaway. Also indicates the start of another program and chapter.
t5	Indicates the end of the program and chapter. Also indicates explicit resumption of the earlier program with implicit chapter resumption.
t6	Indicates an explicit start of an overlapping programming and start of overlapping chapter.
t7	Indicates end of original program and chapter. At this point the overlapped program and chapter are the only active program and chapter.
t8	Indicates end of the overlapped program and chapter.

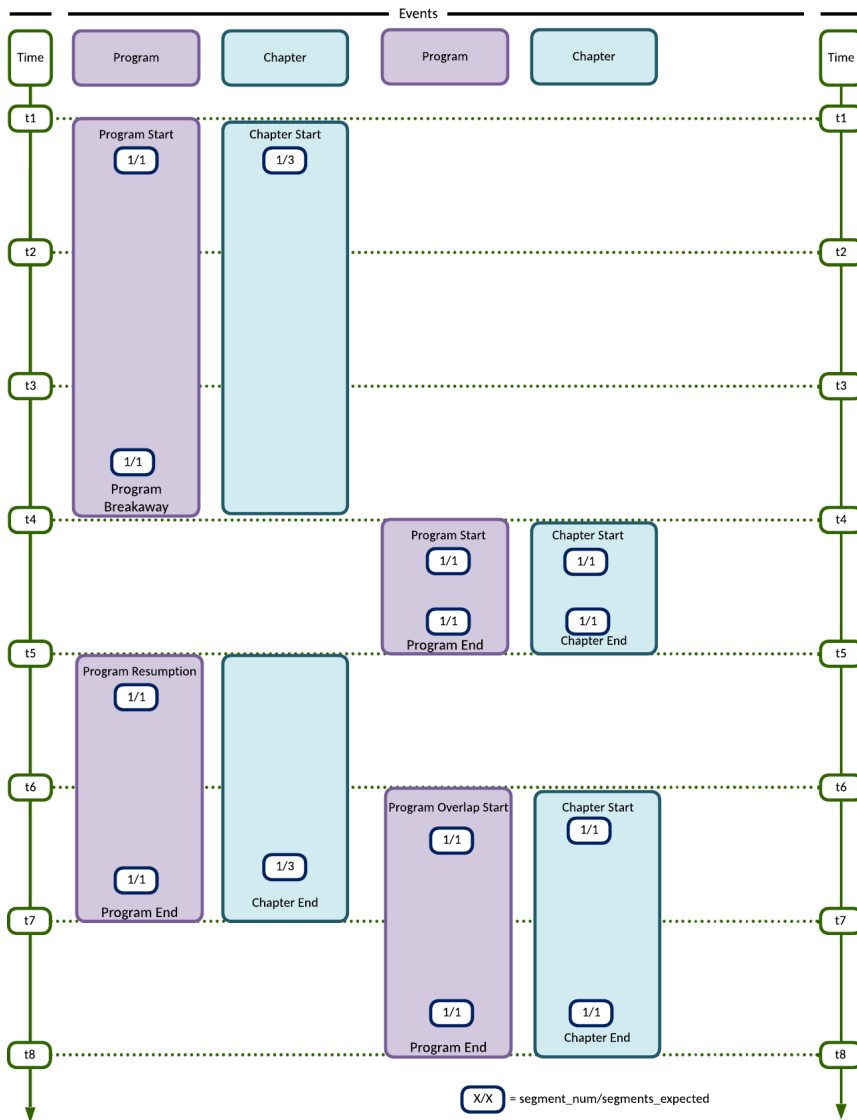

Figure 3 - SCTE 35 Program Content Example – Program Control

6.7.2. SCTE 35 Ad Break Examples

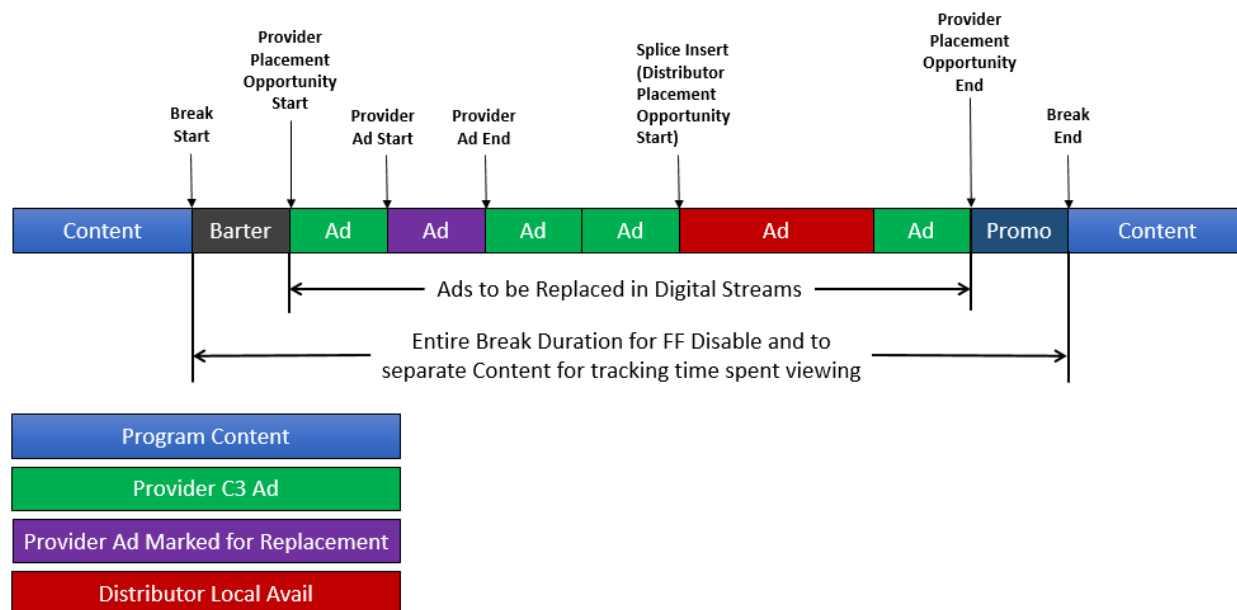

Figure 4 - SCTE 35 Ad Break Example

When a Content Provider inserts non-program content into a Program, it typically falls into one of several categories.

- 1) Promotional Items – These are clips that usually promote other programming by the programmer or may be public service announcements. In children’s programming keeping these intact may be a regulatory matter and they are typically not replaced.
- 2) Barter ads – Some programmers purchase content from studios and the studio reserves the right to insert some advertising. As such, these ads are not usually replaceable.
- 3) Provider C3 ad – These are programmer inserted Advertisements. They are meant to be displayed to a measured audience and may be replaced on devices that are not measured in the traditional sense. Some programmers may use out of band methods such as SCTE 224 to allow these ads to be replaced after a certain amount of time, typically after the C3 windows expires.
- 4) Provider ad marked for replacement – One version of addressable advertising sells a particular ad slot to a single advertiser and plays an ad addressed to the most likely viewing demographic audience (network, show, time of day, etc.) in the original programmer feed. It also marks the individual ad for possible addressable replacement if the device is capable and if the audience information to do so is available. One example would be a car company with a minivan ad for a typical family show, but able to switch to a sports car or truck ad if it is known that the targeted demographic is not watching.
- 5) Distributor Local Avail – This is a legacy distributor Break. It should be signaled with a Distributor Placement Opportunity instead of a splice_insert, although currently deployed systems may not work.

Explanation of the SCTE 35 signaling used:

- 1) Break Start/End – These are inserted to mark the edges of non-program material. This can be used, for example, to disable fast forward during the Break to ensure barter ads and others are

seen and measured. It could also be used to remove the entire Break to repurpose the content for future use.

- 2) Provider Placement Opportunity Start/End – These signals mark an entire block of ads that *may* be replaced. The decision to actually replace the entire Break is based on many factors including live vs restart vs lookback viewing, device, demographics, etc. If the distributor local avail is embedded inside this Break, one should use the MID structure to include information about pod position and length of the local avail; in this way, one will be able to stitch together all of the programmer and distributor ads and any required slate for a seamless user presentation.
- 3) Provider Advertisement Start/End – If a programmer wants to have a downstream system replace an individual ad, they can use this to mark that ad. They would typically use an Ad-ID identifier for the segmentation UPID.
- 4) splice_insert – This is a legacy construct indicating where the local affiliate Breaks occur.

Figure 5 illustrates Advertising Segmentation use cases including Program Immediate Resumption during an Advertising Segment. Advertisements include Provider Advertisements, Distributor Advertisements, Distributor Promo and Provider Promo segments. A Program Immediate Resumption allows a Provider to notify a Distributor to suspend any active ad insertion within a break and return to programming (ex. early return to a live event).

Whether a given message is actionable or not for a given end point (ex. Distributor, delivery model, etc.) is out of scope. A range of approaches can be leveraged including filtering of messages during distribution (ex. Tiering), external data (ex. SCTE 224), carriage agreements, etc.

Time	Description
t2	Indicates the start of a break and the first ad delivered.
t3	Indicates end of first ad delivered plus the start of a Provider Placement Opportunity, 2 Distributor Placement Opportunities and the second ad delivered.
t4	Indicates end of second ad delivered and one of the Distributor Placement Opportunities. Also indicates the start of another Distributor Placement Opportunity and the third ad delivered.
t5	Indicates end of third ad delivered and one of the Distributor Placement Opportunities. Also indicates the start of the fourth ad delivered.
t6	Indicates end of the break, Provider Placement Opportunity, Distributor Placement Opportunity and fourth ad delivered.
t7	Indicates start of a break, Provider Placement Opportunity and the first ad delivered.
t8	Indicates end of Provider Placement Opportunity and first ad delivered. Also, indicates start of 2 Distributor Placement Opportunities and the second ad delivered.
t9	Indicates end of the break, Distributor Placement Opportunity and the second ad delivered. Also, indicates the start of a break, Provider Placement Opportunity, and the first ad delivered in the new break.
t10	Indicates end of Distributor Placement Opportunity and first ad delivered. Also, indicates 2 Distributor Placement Opportunities and second ad delivered in the break.
t11	Indicates end of break, Provider Placement Opportunity, Distributor Placement Opportunities and second ad delivered in the break.

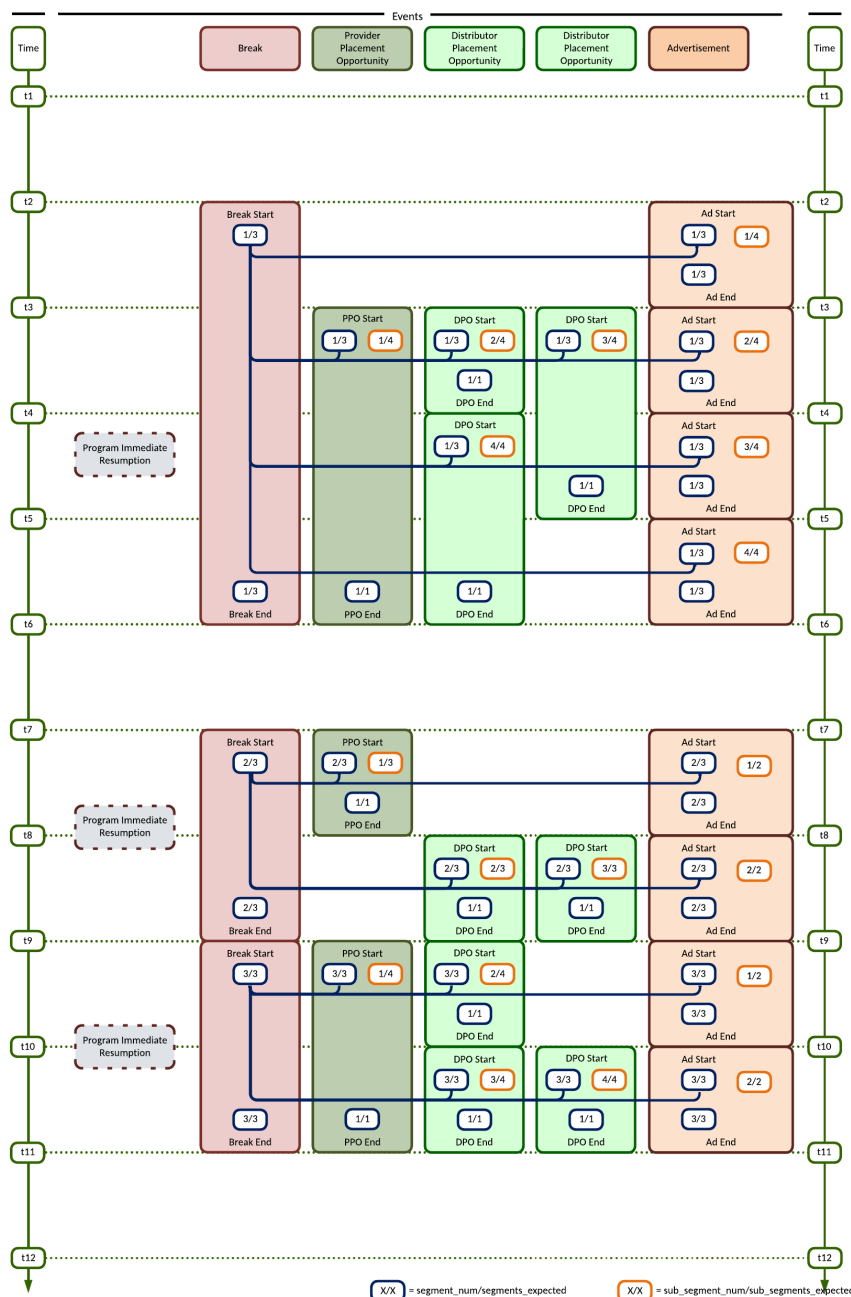

Figure 5 - SCTE 35 Advertising Example – Opportunities and Ad Identification

7. Notational Conventions

7.1. Normative XML schema

Descriptions of elements and attributes are normative and, when combined with the normative XML schema document (provided separately), comprise the full normative schema specification. Unless otherwise specified, the normative text and values assigned to elements or attributes in this specification **shall** be constrained by the bit stream equivalent field.

Non-normative schema illustrations and instance examples are included herein for informational purposes only. Any real or implied usage, semantics, or structure indicated by the schema illustrations and examples **shall not** be considered part of the specification.

No XML documents representing the structures defined in the schema are considered conformant unless they are valid according to the schema document. Additionally, other SCTE 35 standard normative parts *may* impose additional rules or restrictions that **shall** be adhered to in order for XML documents to be considered conformant to those parts.

In the case where this document and the normative schema document (i.e., the separately provided XML ‘xsd’ file) conflict, this document **shall** take precedence over the XML schema document.

The inclusion of a normative XML schema document does not require or imply the specific use of the schema nor a requirement that an XML document be validated.

If the SCTE 35 schema is used in combination with other schemas, it is recommended to utilize the namespace prefix of “SCTE35”. For example, SCTE35:SpliceInsertType to reference an SCTE 35 SpliceInsert Type.

7.1.1. XML namespace and version

The following XML namespaces and versions are defined in the normative XML schema for this specification:

Prefix	Namespace	Version
scte35	http://www.scte.org/schemas/35	20230713

7.2. Unknown/Unrecognized/Unsupported XML elements and attributes

Generally, unknown, unrecognized or unsupported XML elements and attributes contained within SCTE 35 elements *should* be ignored during XML document processing. Specifically, these are elements or attributes which the implementation does not understand or expect. XML parsers that encounter elements or attributes which are prohibited by a namespace *should* include exception handling.

7.3. Element order

Element order is constrained by the schemas and **shall** be preserved throughout processing of the XML document. In particular, the order of elements affects the end result of the processing. Consequently, an implementation failing to preserve the order *may* cause incorrect processing results. Subsequently, the process of producing an abstract XML Information Set (InfoSet) from a concrete XML document, e.g., by parsing it, **shall** always result in the same abstract InfoSet, with the same element order per XML InfoSet (see [XML InfoSet] for additional information). Any intermediary processing *may* enhance the XML document but it **shall not** alter the abstract InfoSet element order (i.e., the XML elements comprising the document **shall** stay in document order).

7.4. Binary representation in XML

The content of a SpliceInfoSection (see Section 9.6) *may* be represented in XML as either a fully parsed structure or as a binary representation. This choice is provided in the XML Schema as a Signal group (Figure 6). The binary representation **shall** be Base64 encoded per [RFC 4648]. The Binary element

should be assumed to contain a SpliceInfoSection unless explicitly indicated by the signalType attribute as something else. The signalType attribute is provided to allow some flexibility in how the XML Schema is used for binary representations. Whenever the value of signalType is not “SpliceInfoSection” it **shall** be prefixed with the text “private:”

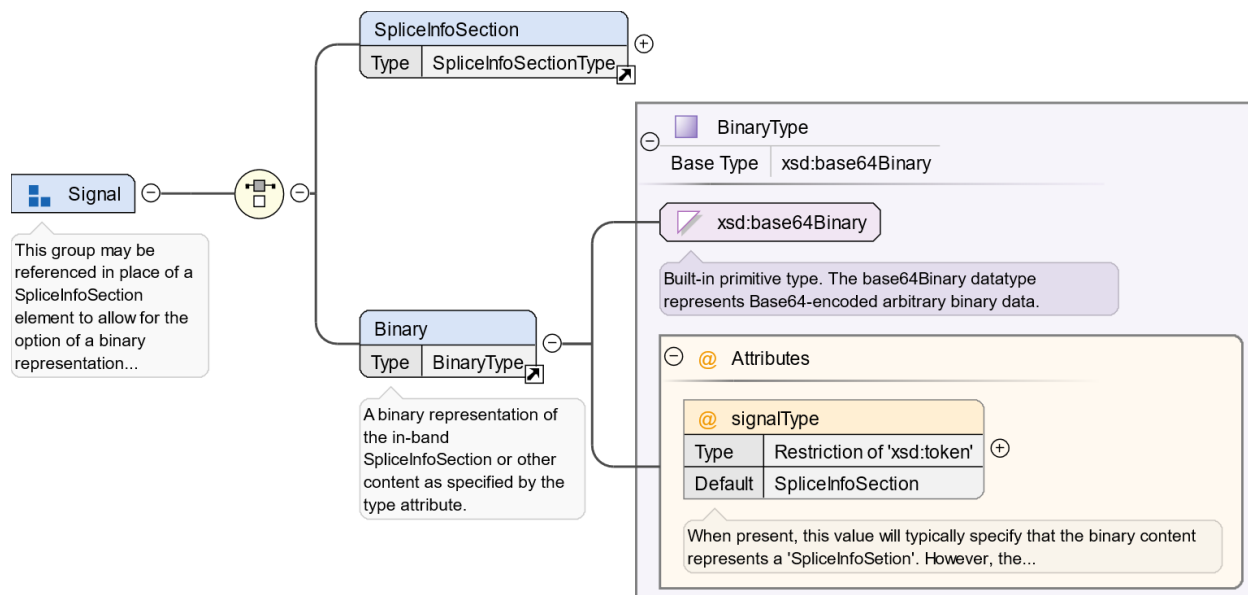

Figure 6 - SignalGroup

8. PMT Descriptors

8.1. Registration descriptor

The registration descriptor (see [MPEG Systems], table 2-46 – Registration Descriptor, clause 2.6.8) is defined to identify unambiguously the programs that comply with this standard. The registration descriptor **shall** be carried in the program_info loop of the PMT for each program that complies with this standard. It **shall** reside in all PMTs of all complying programs within a multiplex. The presence of the registration descriptor also indicates that, when signaling splice events, splice_info_sections **shall** be carried in one or more PID stream(s) within this program.

Presence of this registration descriptor in the PMT signals the following:

1. The program elements do not include the splice information table defined by [SMPTE 312].
2. The only descriptors that can be present in the ES_descriptor_loop of the PMT for the PID(s) that carry the splice_information_table are those that are defined in this specification or user private descriptors.

Note that this descriptor applies to the indicated program and not to the entire multiplex. The content of the registration descriptor is specified in Table 1 and below:

Table 1 - registration_descriptor()

Syntax	Bits	Mnemonic
registration_descriptor() {		
descriptor_tag	8	uimsbf
descriptor_length	8	uimsbf
SCTE splice format identifier	32	uimsbf
}		

8.1.1. Semantic definition of fields in Registration Descriptor

descriptor_tag – The descriptor_tag is an 8-bit field that identifies each descriptor. For registration purposes, this field *shall* be set to 0x05.

descriptor_length – The descriptor_length is an 8-bit field specifying the number of bytes of the descriptor immediately following descriptor_length field. For this registration descriptor, descriptor_length *shall* be set to 0x04.

SCTE_splice_format_identifier – SCTE has assigned a value of 0x43554549 (ASCII “CUEI”) to this 4-byte field to identify the program (within a multiplex) in which it is carried as complying with this standard.

8.2. Cue Identifier Descriptor

The cue_identifier_descriptor *may* be used in the PMT to label PIDs that carry splice commands so that they can be differentiated as to the type or level of splice commands they carry. The cue_identifier_descriptor, when present, *shall* be located in the elementary descriptor loop. If the cue_identifier_descriptor is not utilized, the stream *may* carry any valid command in this specification.

Table 2 - cue_identifier_descriptor()

Syntax	Bits	Mnemonic
cue_identifier_descriptor() {		
descriptor_tag	8	uimsbf
descriptor_length	8	uimsbf
cue stream type	8	uimsbf
}		

8.2.1. Semantic definition of fields in Cue Identifier Descriptor

descriptor_tag – The descriptor_tag is an 8-bit field that identifies each descriptor. For cue_identifier_descriptor, this field *shall* be set to 0x8A.

descriptor_length – The descriptor_length in an 8-bit field specifying the number of bytes of the descriptor immediately following descriptor_length field. For this descriptor, descriptor_length *shall* be set to 0x01.

cue_stream_type – This 8-bit field is defined in Table 3.

Table 3 - cue_stream_type values

cue_stream_type	PID usage
0x00	splice_insert, splice_null, splice_schedule
0x01	All Commands
0x02	Segmentation
0x03	Tiered Splicing
0x04	Tiered Segmentation
0x05-0x7f	Reserved
0x80 - 0xff	User Defined

8.2.2. Description of cue_stream_type usage

0x00 – splice_insert, splice_null, splice_schedule – Only these cue messages are allowed in this PID stream. There *shall* be a maximum of one PID identified with this cue_stream_type. If this PID exists, it *shall* be the first stream complying with this standard in the PMT elementary stream loop.

0x01 – All Commands – Default if this descriptor is not present. All messages can be used in this PID.

0x02 – Segmentation – This PID carries the time_signal command and the segmentation descriptor. It *may* also carry all other commands if needed for the application, but the primary purpose is to transmit content segmentation information.

0x03 – Tiered Splicing – Tiered Splicing refers to an insertion system where the operator provides different inserted Program possibilities in a given avail for different customers. The physical and logical implementation *may* be done in several different manners, some of them outside the scope of this standard.

0x04 – Tiered Segmentation – Tiered Segmentation refers to a system where the operator provides different Program segmentation possibilities for different customers. The physical and logical implementation *may* be done in several different manners, some of them outside the scope of this standard.

0x05-0x7F – Reserved for future extensions to this standard.

0x80-0xFF – User defined range.

8.3. Stream Identifier Descriptor

The stream identifier descriptor *may* be used in the PMT to label component streams of a service so that they can be differentiated. The stream identifier descriptor *shall* be located in the elementary descriptor loop following the relevant ES_info_length field. The stream identifier descriptor *shall* be used if either the program_splice_flag or the program_segmentation_flag is zero. If stream identifier descriptors are used, a stream identifier descriptor *shall* be present in each occurrence of the elementary stream loop within the PMT and *shall* have a unique component tag within the given program.

Table 4 - stream_identifier_descriptor()

Syntax	Bits	Mnemonic
stream_identifier_descriptor() {		
descriptor_tag	8	uimsbf
descriptor_length	8	uimsbf
component_tag	8	uimsbf
}		

8.3.1. Semantic definition of fields in Stream Identifier Descriptor

descriptor_tag – The descriptor_tag is an 8-bit field that identifies each descriptor. For stream_identifier_descriptor, this field *shall* be set to 0x52.

descriptor_length – The descriptor_length in an 8-bit field specifying the number of bytes of the descriptor immediately following descriptor_length field. For this descriptor, descriptor_length *shall* be set to 0x01.

component_tag – This 8-bit field identifies the component stream for associating it with a description given in a component descriptor. Within a program map section each stream identifier descriptor *shall* have a different value for this field.

9. Splice information table

9.1. Overview

The splice information table provides command and control information to the splicer. It notifies the splicer of splice events in advance of those events. It is designed to accommodate ad insertion in network feeds. In this environment, examples of splice events would include 1) a splice out of a network feed into an ad, or 2) the splice out of an ad to return to the network feed. The splice information table *may* be sent multiple times and splice events *may* be cancelled. Syntax for a splice_info_section is defined to convey the splice information table. The splice_info_section is carried on one or more PID stream(s) with the PID(s) declared in that program's PMT.

A splice event indicates the opportunity to splice one or more elementary streams within a program. Each splice event is uniquely identified with an event id (splice_insert() splice_event_id, splice_schedule splice_event_id or time_signal() with segmentation_descriptor segmentation_event_id). See Section 9.9.3 for specific constraints on event id. Splice events *may* be communicated in three ways: they *may* be scheduled ahead of time, a pre-roll warning *may* be given, or a command *may* be given to execute the splice event at specified Splice Points. These three types of messages are sent via the splice_info_section. The splice_command_type field specifies the message being sent. Depending on the value of this field, different constraints apply to the remaining syntax.

The following command types are specified: splice_null(), splice_schedule(), splice_insert(), time_signal() and bandwidth_reservation(). If the Receiving Device does not support a command, it can ignore the entire splice_info_section.

The splice_null(), splice_schedule() and splice_insert() are the legacy commands used in this standard and there is substantial installed base that expects to use these commands in order to perform ad insertions. An alternative mechanism is defined using the time_signal() command to signal splice events in new applications where there is control over the installed equipment.

In order to give advance warning of an impending splice (a pre-roll function), a `splice_insert()` or `time_signal()` command could be sent multiple times before the Splice Point. For example, the command could be sent at 8, 5, 4 and 2 seconds prior to the packet containing the related Splice Point. In order to meet other splicing deadlines in the system, any message received with less than 4 seconds of advance notice may not create the desired result.

Please refer to section 9.9.2.1 for further constraints on the use of pre-roll with `splice_insert()`.

9.2. Legacy Command Descriptions

The `splice_null()` command is provided for extensibility. It can be used as a means of providing a heartbeat message to downstream splicing equipment.

The `splice_schedule()` command is a command that allows a schedule of splice events to be conveyed in advance.

The `splice_insert()` command **shall** be sent at least once before each legacy Splice Point. Packets containing the entirety of the `splice_info_table` **shall** always precede the packet that contains the related Splice Point (i.e., the first packet that contains the first byte of an access unit whose presentation time most closely matches the signaled time in the `splice_info_section`).

The `splice_insert()` command provides for an optional `break_duration()` structure to identify the length of the commercial Break. It is recommended that `splice_insert()` messages with the `out_of_network_indicator` set to 1 (a network Out Point) include a `break_duration()` structure to provide the splicer with an indication of when the network In Point will occur. The `break_duration()` structure provides for an optional `auto_return` flag that, when set to 1, indicates that the splicer is to return to the network at the end of the Break (defined as Auto Return Mode, refer to Section 9.9.2.2). It is recommended that this Auto Return Mode be used to support dynamic avail durations.

The `bandwidth_reservation()` command is provided to allow command insertion devices to utilize a consistent amount of transport stream bandwidth. Descriptors *may* be used in this command, but they cannot be expected to be processed and sent downstream to provide signaling information.

9.3. Time Signal Command

The `time_signal()` command is provided for extensibility by adding descriptors while preserving the precise timing allowed in the `splice_insert()` command. This is to allow for new features utilizing the timing capabilities of this specification while causing minimal impact to the splicing devices that conform to this specification.

A `splice_insert()` command typically instructs an encoder to condition the stream for a splice event. When a `time_signal()` command is used to signal splice events, it **shall** carry one or more segmentation descriptors() with additional information to determine what *may* need to be done to the stream. For example, a `segmentation_descriptor()` with a Provider Placement Opportunity or Program Start would likely indicate that the stream should be conditioned at the time indicated. There *may* also be out of band communications that can control the implementation for example [SCTE 224] and/or [SCTE 250].

9.4. Command Changes

There are two methods for changing the parameters of a command once it has been issued. One method is to cancel the issued command by sending a `splice_info_section` with the `splice_event_cancel_indicator` set and then to send a new `splice_info_section` with the correct/new parameters. The other method is to

simply send a subsequent message with the new data (without canceling the old message via a cue message that has the splice_event_cancel_indicator bit set).

9.5. Time base discontinuities

In the case where a system time base discontinuity is present, packets containing a splice_insert() or time_signal() command with time expressed in the new time base **shall not** arrive prior to the occurrence of the time base discontinuity. Packets containing a splice_insert() or time_signal() command with time expressed in the previous time base **shall not** arrive after the occurrence of the time base discontinuity. See [ISO 13818-4].

The complete syntax is presented below, followed by definition of terms, followed by constraints.

9.6. Splice info section

The splice_info_section **shall** be carried in transport packets whereby only one section or partial section *may* be in any transport packet. Splice_info_sections **shall** always start at the beginning of a transport packet payload. When a section begins in a transport packet and this is the first packet of the splice_info_section, the pointer_field **shall** be present and equal to 0x00 and the payload_unit_start_indicator bit **shall** be equal to one (per the requirements of section syntax usage per [MPEG Systems]).

Table 5 - splice_info_section()

Syntax	Bits	Mnemonic	Encrypted
splice_info_section() {			
table_id	8	uimsbf	
section_syntax_indicator	1	bslbf	
private_indicator	1	bslbf	
sap_type	2	bslbf	
section_length	12	uimsbf	
protocol_version	8	uimsbf	
encrypted_packet	1	bslbf	
encryption_algorithm	6	uimsbf	
pts_adjustment	33	uimsbf	
cw_index	8	uimsbf	
tier	12	bslbf	
splice_command_length	12	uimsbf	
splice_command_type	8	uimsbf	E
if(splice_command_type == 0x00)			
splice_null()			E
if(splice_command_type == 0x04)			
splice_schedule()			E
if(splice_command_type == 0x05)			
splice_insert()			E
if(splice_command_type == 0x06)			
time_signal()			E
if(splice_command_type == 0x07)			
bandwidth_reservation()			E
if(splice_command_type == 0xff)			
private_command()			E
descriptor_loop_length	16	uimsbf	E
for(i=0; i<N1; i++)			
splice_descriptor()			E
for(i=0; i<N2; i++)			
alignment_stuffing	8	bslbf	E
if(encrypted_packet)			
E_CRC_32	32	rpchof	E
CRC_32	32	rpchof	
}			

The XML schema for splice_info_section is shown in Figure 7.

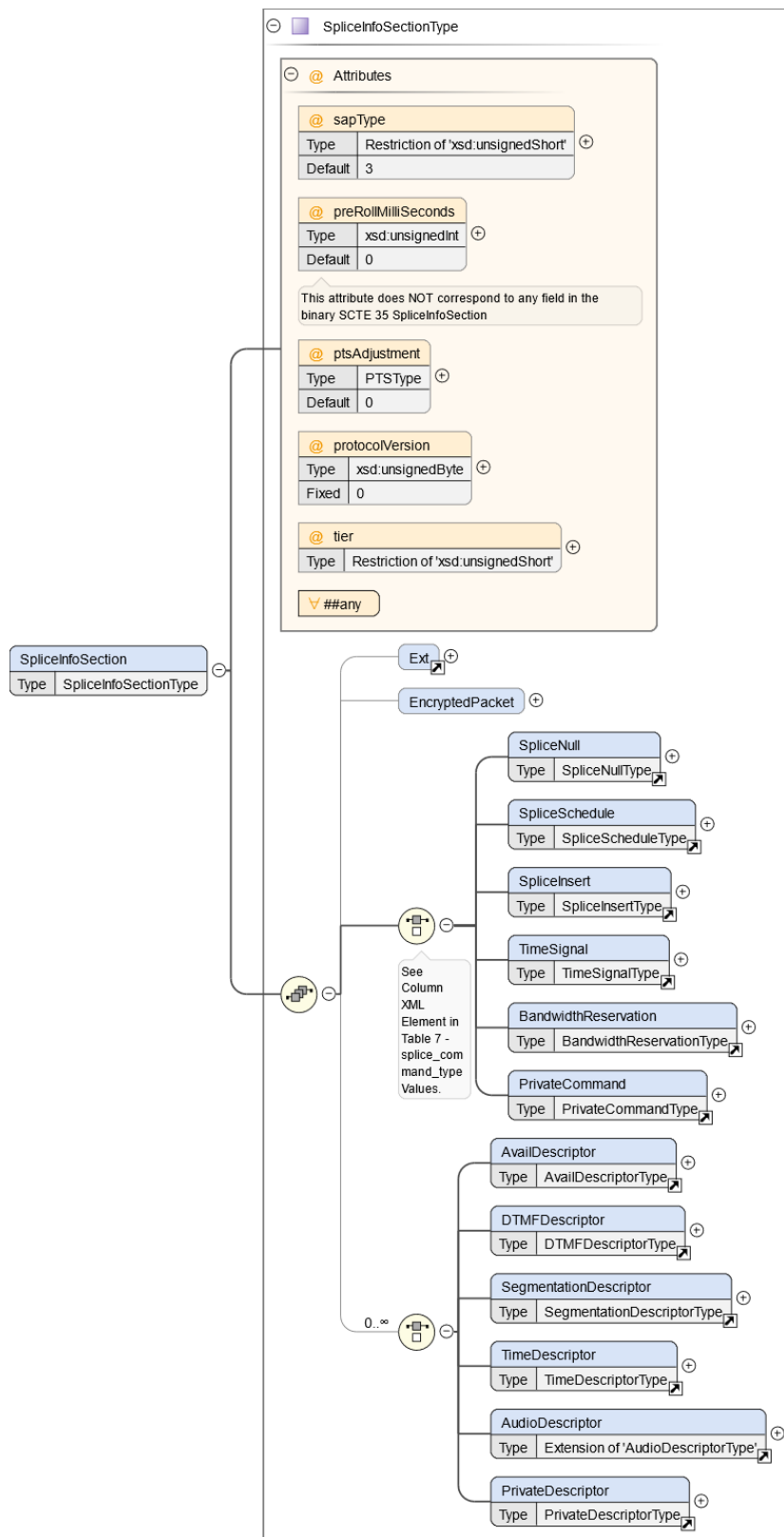

Figure 7 - SpliceInfoSection

9.6.1. Semantic definition of fields in splice_info_section()

table_id – This is an 8-bit field. Its value *shall* be 0xFC.

There is no entry in the XML schema for table_id. The value is implicit when transforming to or from an XML representation of the splice_info_section.

section_syntax_indicator – The section_syntax_indicator is a 1-bit field that *should* always be set to ‘0’, indicating that MPEG short sections are to be used.

There is no entry in the XML schema for section_syntax_indicator. The value is a constant when converting an XML representation of the splice_info_section to Bit Stream Format.

private_indicator – This is a 1-bit flag that *shall* be set to 0.

There is no entry in the XML schema for private_indicator. The value is a constant when converting an XML representation of the splice_info_section to Bit Stream Format.

sap_type – A two-bit field that *may* be populated if the content preparation system has created a Stream Access Point (SAP) at the signaled point in the stream. SAP types are defined in ISO 14496-12, Annex I. The semantics of SAP types are further informatively elaborated in ISO/IEC 23009-1 [[DASH], Section 4.5.2. The sap_type field *shall* be assigned one of the values shown in the column labeled sap_type value in Table 6. Content preparation systems can be encoders, transcoders or other systems.

Table 6 - sap_type values

sap_type value	ISOBMFF SAP type	Usage Notes
0x0	Type 1	Closed GOP with no leading pictures
0x1	Type 2	Closed GOP with leading pictures
0x2	Type 3	Open GOP
0x3	SAP type not specified	The type of SAP, if any, is not signaled

Note: prior versions of this specification required that this field be set to 0x3².

@sapType [Optional; xsd:unsignedShort; default=3]

section_length – This is a 12-bit field specifying the number of remaining bytes in the splice_info_section, immediately following the section_length field up to the end of the splice_info_section. The value in this field *shall not* exceed 4093.

There is no entry in the XML schema for section_length. The value *shall* be derived when converting an XML representation of the splice_info_section to Bit Stream Format.

² Readers who are unfamiliar with [MPEG Systems] should understand that the previous definition of these bits was as “reserved” bits, which are always set to ‘1’.

protocol_version – An 8-bit unsigned integer field whose function is to allow, in the future, this table type to carry parameters that *may* be structured differently than those defined in the current protocol. At present, the only valid value for protocol_version protocolVersion [Optional; xsd:unsignedByte] is zero. Non-zero values of protocol_version *may* be used by a future version of this standard to indicate structurally different tables.

@ present, this attribute *shall* be set to 0.

encrypted_packet – When this bit is set to ‘1’, it indicates that portions of the splice_info_section, starting with splice_command_type and ending with and including E_CRC_32, are encrypted. When this bit is set to ‘0’, no part of this message is encrypted. The potentially encrypted portions of the splice_info_table are indicated by an E in the Encrypted column of Table 5.

There is no entry in the XML schema for encrypted_packet. When converting an XML representation of the splice_info_section to Bit Stream Format, this value *shall* be set to 1 if the EncryptedPacket Element is present; otherwise, the value *shall* be set to 0. When creating the SpliceInfoSection Element, the EncryptedPacket Element *shall* be populated if encryption is desired. The encrypted attributes *shall* only apply to the generation of the Bit Stream Format of the splice_info_section. The encrypted attributes may be populated when converting a splice_info_section to XML, but the actual data in the XML *shall not* be encrypted.

encryption_algorithm – This 6-bit unsigned integer specifies which encryption algorithm was used to encrypt the current message. When the encrypted_packet bit is zero, this field is present but undefined. Refer to Section 11, and specifically Table 29, for details on the use of this field.

@encryptionAlgorithm [Conditional Mandatory, xsd:unsignedByte] If the EncryptedPacket Element is present this value *shall* be provided.

pts_adjustment – A 33-bit unsigned integer that appears in the clear and that *shall* be used by a splicing device as an offset to be added to the (sometimes) encrypted pts_time field(s) throughout this message, to obtain the intended splice time(s). When this field has a zero value, then the pts_time field(s) *shall* be used without an offset. Normally, the creator of a cueing message will place a zero value into this field. This adjustment value is the means by which an upstream device, which restamps PCR/PTS/DTS, *may* convey to the splicing device the means by which to convert the pts_time field of the message to a newly imposed time domain.

It is intended that the first device that restamps PCR/PTS/DTS and that passes the cueing message will insert a value into the pts_adjustment field, which is the delta time between this device’s input time domain and its output time domain. All subsequent devices, which also restamp PCR/PTS/DTS, *may* further alter the pts_adjustment field by adding their delta time to the field’s existing delta time and placing the result back in the pts_adjustment field. Upon each alteration of the pts_adjustment field, the altering device *shall* recalculate and update the CRC_32 field.

The pts_adjustment *shall*, at all times, be the proper value to use for conversion of the pts_time field to the current time-base. The conversion is done by adding the two fields. In the presence of a wrap or overflow condition, the carry *shall* be ignored.

@ptsAdjustment [Optional, PTSType] (see Section 13.2).

cw_index – An 8-bit unsigned integer that conveys which control word (key) is to be used to decrypt the message. The splicing device *may* store up to 256 keys previously provided for this purpose. When the encrypted_packet bit is zero, this field is present but undefined.

@cwIndex [Conditional Mandatory, xsd:unsignedByte] If the EncryptedPacket Element is present this value **shall** be provided.

tier – A 12-bit value used by the SCTE 35 message provider to assign messages to authorization tiers. This field *may* take any value between 0x000 and 0xFFF. The value of 0xFFF provides backwards compatibility and **shall** be ignored by downstream equipment. When using tier, the message provider *should* keep the entire message in a single transport stream packet.

@tier [Optional, xsd:unsignedShort]

splice_command_length – A 12-bit length of the splice command. The length **shall** represent the number of bytes following the *splice_command_type* up to, but not including the *descriptor_loop_length*. Devices that are compliant with this version of the standard **shall** populate this field with the actual length. The value of 0xFFF provides backwards compatibility and **shall** be ignored by downstream equipment.

There is no entry in the XML schema for splice_command_length. The value **shall** be derived when converting an XML representation of the splice_info_section to Bit Stream Format.

splice_command_type – An 8-bit unsigned integer which **shall** be assigned one of the values shown in column labeled splice_command_type value in Table 7.

There is no entry in the XML schema for splice_command_type. The value is implicit when transforming to or from an XML representation of the splice_info_section based on the specific command Element supplied. The Element names can be found in the XML Element column in Table 7.

Table 7 - splice_command_type values

Command	splice_command_type value	XML Element
splice null	0x00	SpliceNull
Reserved	0x01	
Reserved	0x02	
Reserved	0x03	
splice schedule	0x04	SpliceSchedule
splice insert	0x05	SpliceInsert
time signal	0x06	TimeSignal
bandwidth reservation	0x07	BandwidthReservation
Reserved	0x08 - 0xfe	
private command	0xff	PrivateCommand

descriptor_loop_length – A 16-bit unsigned integer specifying the number of bytes used in the splice descriptor loop immediately following.

There is no entry in the XML schema for descriptor_loop_length. The value **shall** be derived when converting an XML representation of the splice_info_section to Bit Stream Format.

alignment_stuffing – When encryption is used, this field is a function of the particular encryption algorithm chosen. Since some encryption algorithms require a specific length for the encrypted data, it is necessary to allow the insertion of stuffing bytes. For example, DES requires a multiple of 8 bytes be present in order to encrypt to the end of the packet. This allows standard DES to be used, as opposed to requiring a special version of the encryption algorithm.

When encryption is not used, this field **shall not** be used to carry valid data, but may be present.

There is no entry in the XML schema for alignment_stuffing. The required data *shall* be derived when converting an XML representation of the splice_info_section to Bit Stream Format.

E_CRC_32 – This is a 32-bit field that contains the CRC value that gives a zero output of the registers in the decoder defined in [MPEG Systems]after processing the entire decrypted portion of the splice_info_section. This field is intended to give an indication that the decryption was performed successfully. Hence, the zero output is obtained following decryption and by processing the fields splice_command_type through E_CRC_32.

There is no entry in the XML schema for E_CRC_32. The value *shall* be derived when converting an XML representation of the splice_info_section to Bit Stream Format.

CRC_32 – This is a 32-bit field that contains the CRC value that gives a zero output of the registers in the decoder defined in [MPEG Systems]after processing the entire splice_info_section, which includes the table_id field through the CRC_32 field. The processing of CRC_32 *shall* occur prior to decryption of the encrypted fields and *shall* utilize the encrypted fields in their encrypted state.

There is no entry in the XML schema for CRC_32. The value *shall* be derived when converting an XML representation of the splice_info_section to Bit Stream Format.

preRollMilliseconds – The preRollMilliseconds attribute provides a mechanism to convey a pre-roll value in milliseconds in an XML formatted SCTE 35 command to an insertion device so a command can be placed in the stream in advance of the signaled Splice Point. This attribute does NOT correspond to any field in the binary SCTE 35 SpliceInfoSection

@preRollMilliseconds [optional, xsd:unsignedInt]

9.7. Splice commands

9.7.1. splice_null()

The splice_null() command is provided for extensibility of the standard. The splice_null() command allows a splice_info_table to be sent that can carry descriptors without having to send one of the other defined commands. This command *may* also be used as a “heartbeat message” for monitoring cue injection equipment integrity and link integrity.

Table 8 - splice_null()

Syntax	Bits	Mnemonic
splice_null() { }		

The XML schema for splice_null is shown in Figure 8.

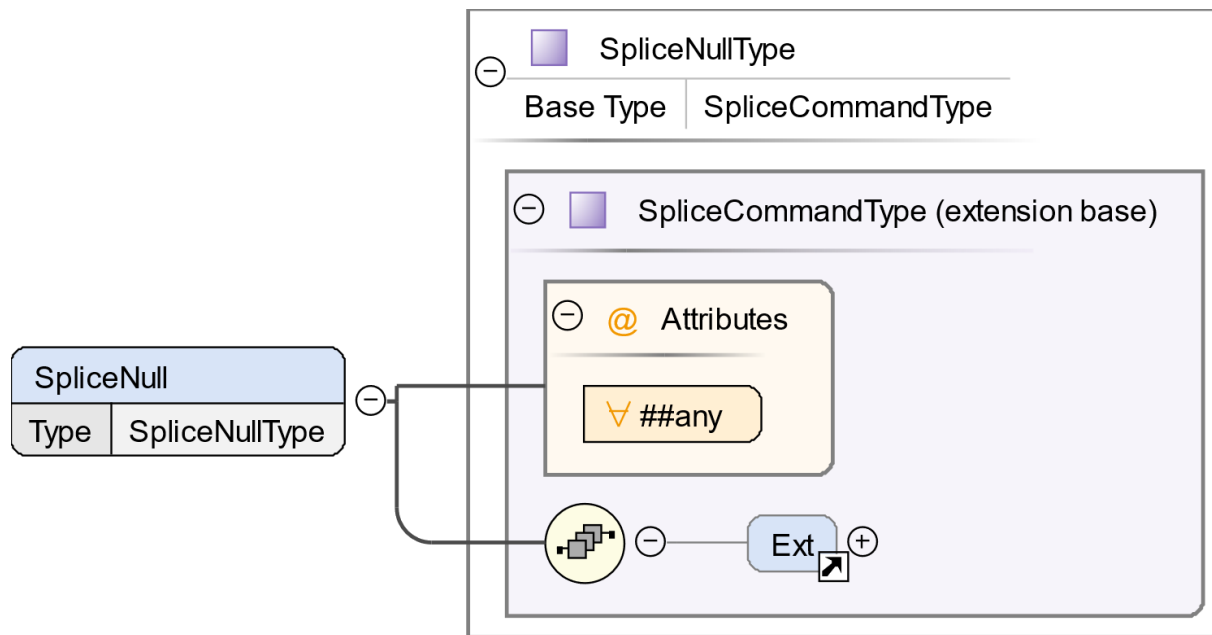

Figure 8 - SpliceNull

9.7.2. splice_schedule()

The splice_schedule() command is provided to allow a schedule of splice events to be conveyed in advance.

Table 9 - splice_schedule()

Syntax	Bits	Mnemonic
splice_schedule() {		
splice_count	8	uimsbf
for (i=0; i<splice_count; i++) {		
splice_event_id	32	uimsbf
splice_event_cancel_indicator	1	bslbf
event_id_compliance_flag	1	bslbf
reserved	6	bslbf
if (splice_event_cancel_indicator == '0') {		
out_of_network_indicator	1	bslbf
program_splice_flag	1	bslbf
duration_flag	1	bslbf
reserved	5	bslbf
if (program_splice_flag == '1')		
utc_splice_time	32	uimsbf
if (program_splice_flag == '0') { ³		
component_count	8	uimsbf
for(j=0;j<component_count;j++) {		
component_tag	8	uimsbf
utc_splice_time	32	uimsbf
}		
}		
if (duration_flag)		
break_duration()		
unique_program_id	16	uimsbf
avail_num	8	uimsbf
avails_expected	8	uimsbf
}		
}		

The XML schema for splice_schedule is shown in Figure 9. NOTE: Component Splice Mode is *deprecated*.

³ Component Splice Mode is deprecated.

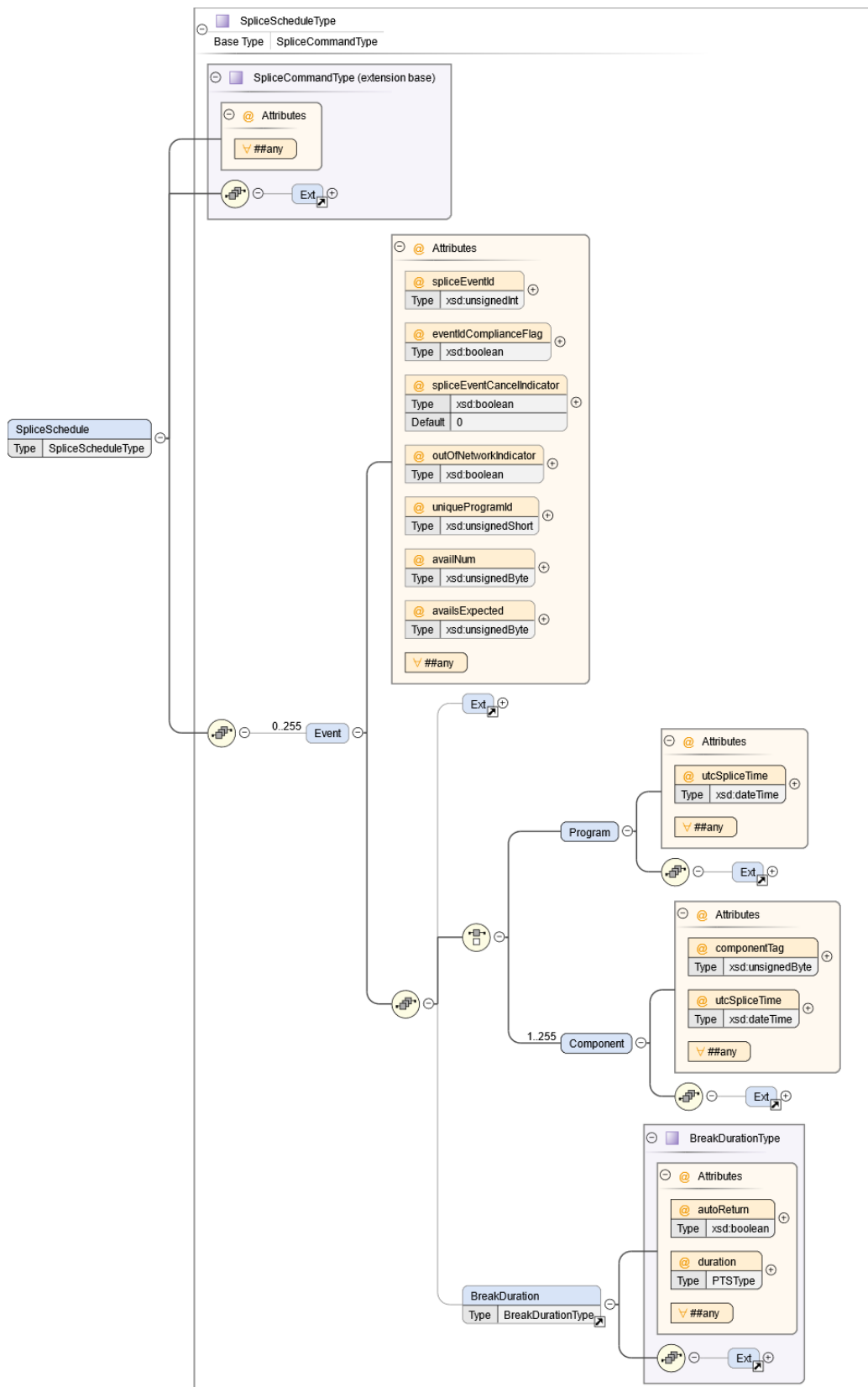

Figure 9 - SpliceSchedule

NOTE:

Component Mode is *deprecated*. The Component Element *should not* be used.

9.7.2.1. Semantic definition of fields in splice_schedule()

splice_count – An 8-bit unsigned integer that indicates the number of splice events specified in the loop that follows.

There is no entry in the XML schema for splice_count. The value *shall* be derived when converting an XML representation of the splice_schedule to Bit Stream Format. Splice_count *shall* be set to the count of Event Elements supplied in the XML document.

splice_event_id – A 32-bit unique splice event identifier.

@spliceEventId [Optional, xsd:unsignedInt]

splice_event_cancel_indicator – A 1-bit flag that, when set to ‘1’, indicates that a previously sent splice event, identified by splice_event_id, has been cancelled.

@spliceEventCancelIndicator [Optional; xsd:boolean] A value of TRUE *shall* be equivalent to a value of ‘1’ and FALSE *shall* be equivalent to a value of ‘0’. If omitted, set splice_event_cancel_indicator to 0 when generating an SCTE 35 splice_schedule message.

event_id_compliance_flag – When this flag is ‘0’, it indicates that the **splice_event_id** value for each Event Element for this splice_schedule() command complies with section 9.9.3. When this flag is ‘1’, compliance with section 9.9.3 is not specified.

@eventIdComplianceFlag [Optional; xsd:boolean] When present and set to “true”, it indicates that the @spliceEventId values in each Event Element in the splice_schedule() command complies with section 9.9.3. Otherwise, set to “false” or omit.

out_of_network_indicator – A 1-bit flag that, when set to ‘1’, indicates that the splice event is an opportunity to exit from the network feed and that the value of utc_splice_time *shall* refer to an intended Out Point or Program Out Point. When set to ‘0’, the flag indicates that the splice event is an opportunity to return to the network feed and that the value of utc_splice_time *shall* refer to an intended In Point or Program In Point.

@outOfNetworkIndicator [Optional, xsd:boolean] A value of TRUE *shall* be equivalent to a value of ‘1’ for out_of_network_indicator in Bit Stream Format.

program_splice_flag – A 1-bit flag that *should* be set to ‘1’, indicates that the message refers to a Program Splice Point and that the mode is the Program Splice Mode whereby all PIDs/components of the program are to be spliced.

Component Splice Mode is *deprecated*. When set to ‘0’, this field indicates that the mode is the Component Splice Mode whereby each component that is intended to be spliced will be listed separately by the syntax that follows.

There is no entry in the XML schema for program_splice_flag. The value of program_splice_flag *shall* be set to ‘1’ when converting an XML representation of the splice_schedule to Bit Stream Format if the Program Element in the Event Element is specified; otherwise, the value of program_splice_flag *shall* be set to ‘0’.

duration_flag – A 1-bit flag that indicates the presence of the break_duration() field.

There is no entry in the XML schema for duration_flag. The value *shall* be derived when converting an XML representation of the splice_schedule to Bit Stream Format. Duration_flag *shall* be set to ‘1’ if a BreakDuration Element is supplied within the Event Element; otherwise, duration_flag *shall* be set to ‘0’. See Section 9.8.2 for a description of the BreakDuration Element.

utc_splice_time – A 32-bit unsigned integer quantity representing the time of the signaled splice event as the number of seconds since 00 hours UTC, January 6th, 1980, with the count of intervening leap seconds included. The utc_splice_time *may* be converted to UTC without the use of the GPS.UTC_offset value provided by the System Time table. The utc_splice_time field is used only in the splice_schedule() command.

@utcSpliceTime [Required, xsd:dateTime] utcSplice time applies to both Program Splice Mode and Component Splice Mode. Component Splice Mode is *deprecated*.

component_count (*Deprecated*) – An 8-bit unsigned integer that specifies the number of instances of elementary PID stream data in the loop that follows. Components are equivalent to elementary PID streams. If program_splice_flag == ‘0’ then the value of component_count *shall* be greater than or equal to 1.

There is no entry in the XML schema for component_count. For Component Splice Mode, the value *shall* be derived when converting an XML representation of the splice_schedule to Bit Stream Format. Component_count *shall* be set to the count of Component Elements supplied within the Event Element in the XML document.

component_tag (*Deprecated*) – An 8-bit value that identifies the elementary PID stream containing the Splice Point specified by the value of splice_time() that follows. The value *shall* be the same as the value used in the stream_identifier_descriptor() to identify that elementary PID stream.

@componentTag [Required, xsd:unsignedByte]

unique_program_id – This value *should* provide a unique identification for a viewing event within the service. Note: See [SCTE 118-2] or [SCTE 224] for guidance in setting values for this field.

@uniqueProgramId [Optional, xsd:unsignedShort]

avail_num – (previously ‘avail’) This field provides an identification for a specific avail within one unique_program_id. This value is expected to increment with each new avail within a viewing event. This value is expected to reset to one for the first avail in a new viewing event. This field is expected to increment for each new avail. It *may* optionally carry a zero value to indicate its non-usage.

@availNum [Optional, xsd:unsignedByte]

avails_expected – (previously ‘avail_count’) This field provides a count of the expected number of individual avails within the current viewing event. When this field is zero, it indicates that the avail_num field has no meaning.

@availsExpected [Optional, xsd:unsignedByte]

9.7.3. splice_insert()

The splice_insert() command is provided to signal an upcoming splice event. Please reference Section 6.3 for the use of this message.

Table 10 - splice_insert()

Syntax	Bits	Mnemonic
splice_insert() {		
splice_event_id	32	uimsbf
splice_event_cancel_indicator	1	bslbf
reserved	7	bslbf
if(splice_event_cancel_indicator == '0') {		
out_of_network_indicator	1	bslbf
program_splice_flag	1	bslbf
duration_flag	1	bslbf
splice_immediate_flag	1	bslbf
event_id_compliance_flag	1	bslbf
reserved	3	bslbf
if((program_splice_flag == '1') && (splice_immediate_flag == '0'))		
splice_time()		
if(program_splice_flag == '0') {4	8	uimsbf
component_count		
for(i=0;i<component_count;i++) {		
component_tag	8	uimsbf
if(splice_immediate_flag == '0')		
splice_time()		
}		
}		
if(duration_flag == '1')		
break_duration()		
unique_program_id	16	uimsbf
avail_num	8	uimsbf
avails_expected	8	uimsbf
}		
}		

The XML schema for splice_insert is shown in Figure 10. NOTE: Component Splice Mode is *deprecated*.

⁴ Component mode is deprecated.

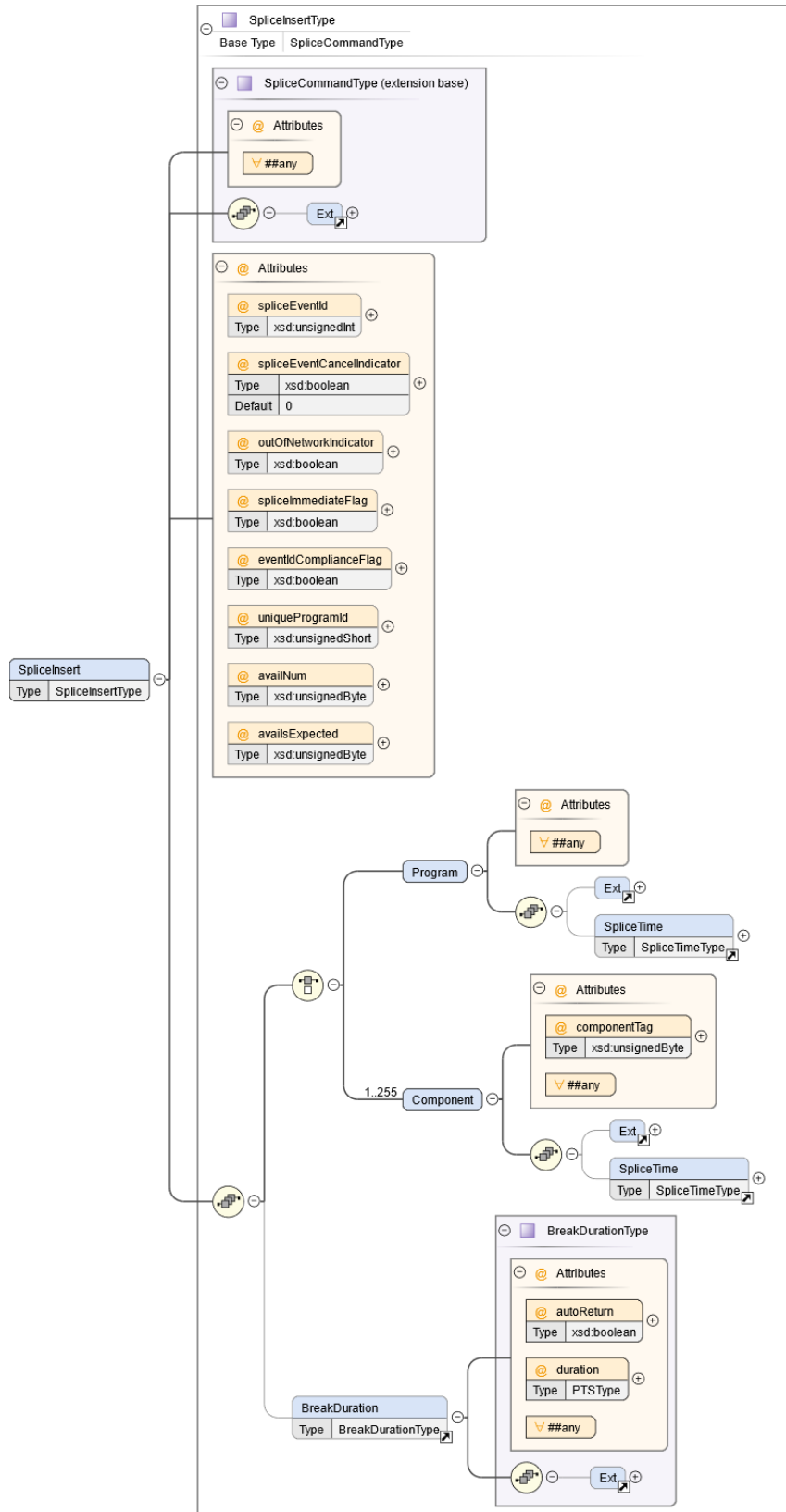

Figure 10 - SpliceInsert

NOTE:

Component Splice Mode is *deprecated*. The Component Element *should not* be utilized.

9.7.3.1. Semantic definition of fields in splice_insert()

splice_event_id – A 32-bit unique splice event identifier.

@spliceEventId [Optional; xsd:unsignedInt]

splice_event_cancel_indicator – A 1-bit flag that, when set to ‘1’, indicates that a previously sent splice event, identified by splice_event_id, has been cancelled.

@spliceEventCancelIndicator [Optional; xsd:boolean] A value of TRUE **shall** be equivalent to a value of ‘1’ and FALSE **shall** be equivalent to a value of ‘0’. If omitted, set splice_event_cancel_indicator to 0 when generating an SCTE 35 splice_insert message.

out_of_network_indicator – A 1-bit flag that, when set to ‘1’, indicates that the splice event is an opportunity to exit from the network feed and that the value of splice_time(), as modified by pts_adjustment, **shall** refer to an intended Out Point or Program Out Point. When set to ‘0’, the flag indicates that the splice event is an opportunity to return to the network feed and that the value of splice_time(), as modified by pts_adjustment, **shall** refer to an intended In Point or Program In Point.

@outOfNetworkIndicator [Optional; xsd:boolean]

program_splice_flag – A 1-bit flag that *should* be set to ‘1’, indicates that the message refers to a Program Splice Point and that the mode is the Program Splice Mode whereby all PIDs/components of the program are to be spliced. Component Splice Mode *deprecated*.

When set to ‘0’, this field indicates that the mode is the Component Splice Mode whereby each component that is intended to be spliced will be listed separately by the syntax that follows. There is no entry in the XML schema for program_splice_flag. The value of program_splice_flag **shall** be set to ‘1’ when converting an XML representation of the splice_insert to Bit Stream Format if the Program Element in the Event Element is specified; otherwise, the value of program_splice_flag **shall** be set to ‘0’. Component Splice Mode *deprecated*.

duration_flag – A 1-bit flag that, when set to ‘1’, indicates the presence of the break_duration() field.

There is no entry in the XML schema for duration_flag. The value **shall** be derived when converting an XML representation of the splice_insert to Bit Stream Format. duration_flag **shall** be set to ‘1’ if a BreakDuration Element is supplied within the SpliceInsert Element; otherwise, duration_flag **shall** be set to ‘0’. See Section 9.8.2 for a description of the BreakDuration Element.

splice_immediate_flag – When this flag is ‘1’, it indicates the absence of the splice_time() field and that the splice mode **shall** be the Splice Immediate Mode, whereby the splicing device **shall** choose the nearest opportunity in the stream, relative to the splice information packet, to splice. When this flag is ‘0’, it indicates the presence of the splice_time() field in at least one location within the splice_insert() command.

@spliceImmediateFlag [Optional; xsd:boolean]

event_id_compliance_flag – When this flag is ‘0’, it indicates that the splice_event_id value complies with section 9.9.3. When this flag is ‘1’, compliance with section 9.9.3 is not specified.

@eventIdComplianceFlag [Optional; xsd:boolean] When present and set to “true”, it indicates that the **@spliceEventId** value complies with section 9.9.3. Otherwise, set to “false” or omit.

component_count (Component Splice Mode *deprecated*) – An 8-bit unsigned integer that specifies the number of instances of elementary PID stream data in the loop that follows. Components are equivalent to elementary PID streams. If **program_splice_flag** == ‘0’ then the value of **component_count** *shall* be greater than or equal to 1.

There is no entry in the XML schema for **component_count**. For Component Splice Mode, the value *shall* be derived when converting an XML representation of the **splice_insert** to Bit Stream Format. **component_count** *shall* be set to the count of Component Elements supplied within the **SpliceInsert** Element in the XML document.

component_tag (Component Splice Mode *deprecated*) – An 8-bit value that identifies the elementary PID stream containing the Splice Point specified by the value of **splice_time()** that follows. The value *shall* be the same as the value used in the **stream_identifier_descriptor()** to identify that elementary PID stream.

@componentTag [Required, xsd:unsignedByte]

unique_program_id – This value *should* provide a unique identification for a viewing event within the service. Note: See [SCTE 118-2] for guidance in setting values for this field.

@uniqueProgramId [Optional; xsd:unsignedShort]

avail_num – (previously ‘avail’) This field provides an identification for a specific avail within one **unique_program_id**. This value is expected to increment with each new avail within a viewing event. This value is expected to reset to one for the first avail in a new viewing event. This field is expected to increment for each new avail. It *may* optionally carry a zero value to indicate its non-usage.

@availNum [Optional, xsd:unsignedByte]

avails_expected – (previously ‘avail_count’) This field provides a count of the expected number of individual avails within the current viewing event. When this field is zero, it indicates that the **avail** field has no meaning.

@availsExpected [Optional, xsd:unsignedByte]

9.7.4. time_signal()

The **time_signal()** provides a time synchronized data delivery mechanism. The syntax of the **time_signal()** allows for the synchronization of the information carried in this message with the System Time Clock (STC). The unique payload of the message is carried in the descriptor, however the syntax and transport capabilities afforded to **splice_insert()** messages are also afforded to the **time_signal()**. The carriage however can be in a different PID than that carrying the other cue messages used for signaling Splice Points.

If the **time_specified_flag** is set to 0, indicating no **pts_time** in the message, then the command *shall* be interpreted as an immediate command. It must be understood that using it in this manner will cause an unspecified amount of accuracy error.

Note: Since the time_signal() command utilizes descriptors for most of the specific information, this command could exceed one MPEG transport packet in length. Implementors are warned that legacy equipment may require this command to completely fit in one transport packet. This will not always be possible in some situations, for example, where the unique information is long or where another specification is used for the definition of this unique information.

Table 11 - time_signal()

Syntax	Bits	Mnemonic
<pre>time_signal() { splice_time() }</pre>		

The XML schema for time_signal is shown in Figure 11.

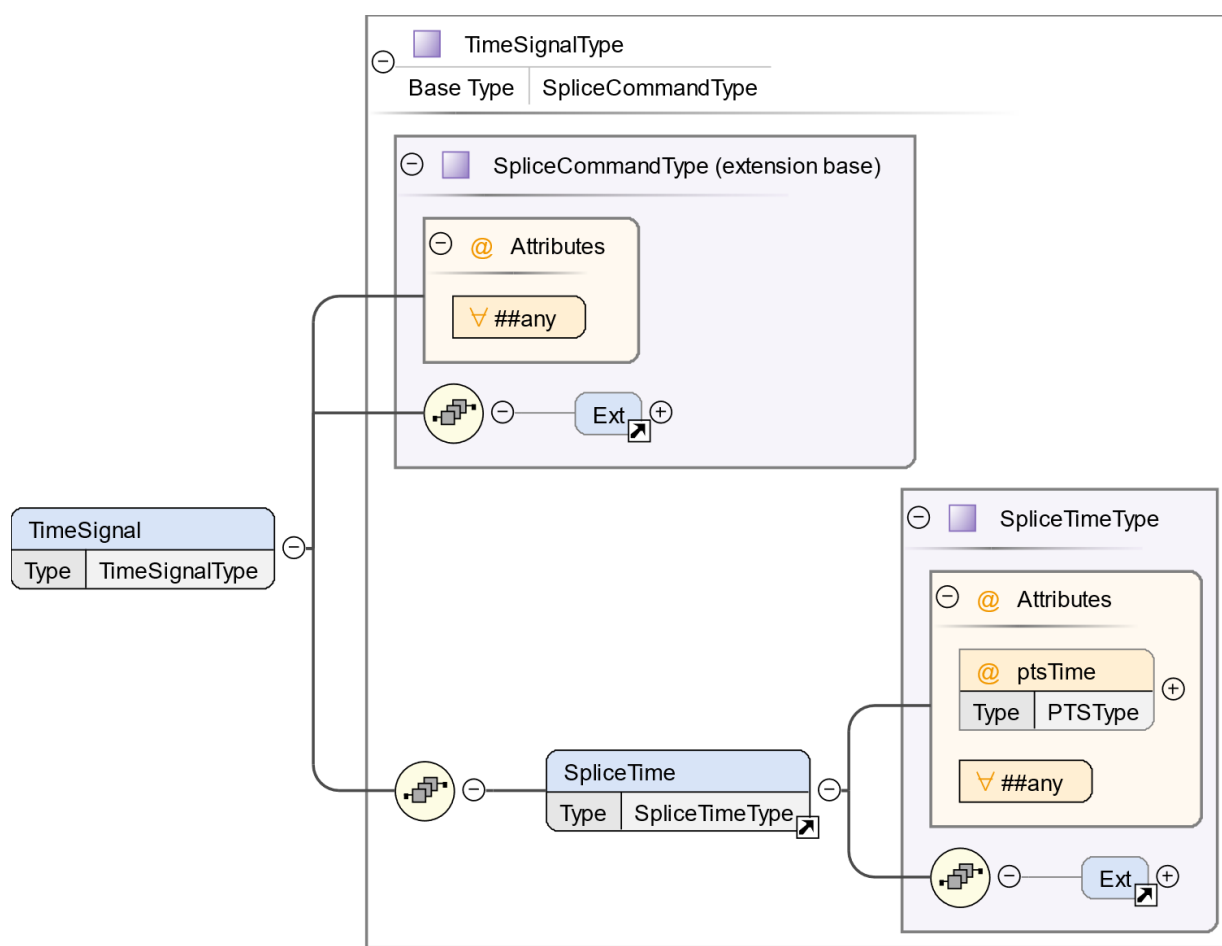

Figure 11 - TimeSignal

9.7.4.1. Semantic definition of time_signal()

The time_signal() provides a uniform method of associating a pts_time sample with an arbitrary descriptor (or descriptors) as provided by the splice_info_section syntax (see Table 5). Please refer to Section 10 for Splice Descriptors.

9.7.5. bandwidth_reservation()

The bandwidth_reservation() command is provided for reserving bandwidth in a multiplex. A typical usage would be in a satellite delivery system that requires packets of a certain PID to always be present at the intended repetition rate to guarantee a certain bandwidth for that PID. This message differs from a splice_null() command so that it can easily be handled in a unique way by receiving equipment (i.e. removed from the multiplex by a satellite receiver). If a descriptor is sent with this command, it cannot be expected that it will be carried through the entire transmission chain and it *should* be a private descriptor that is utilized only by the bandwidth reservation process.

Table 12 - bandwidth_reservation()

Syntax	Bits	Mnemonic
bandwidth_reservation() { }		

The XML schema for bandwidth_reservation is shown in Figure 12.

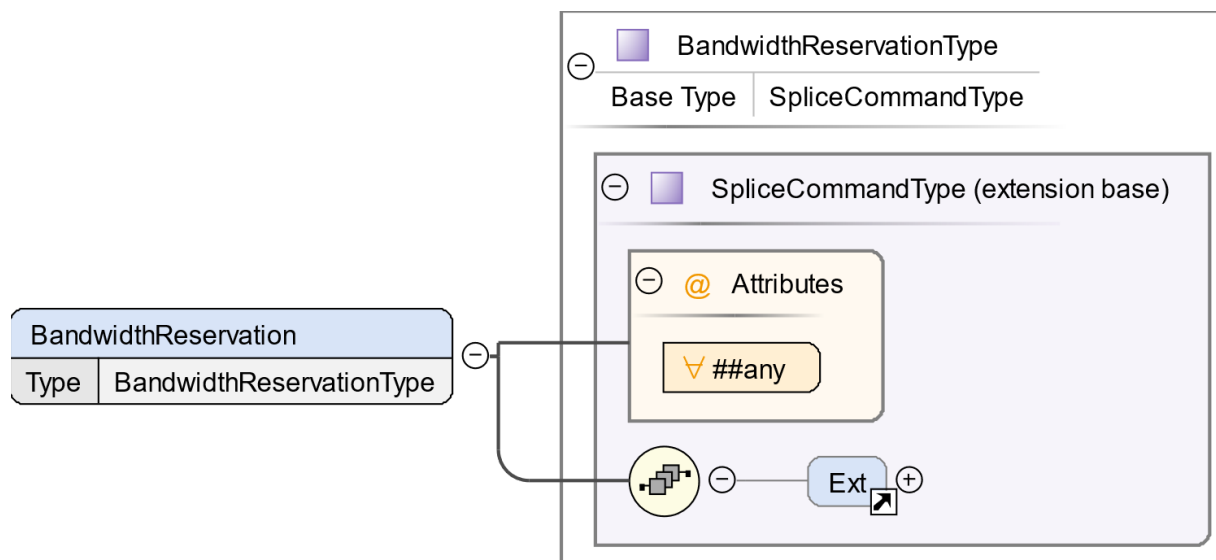

Figure 12 – BandwidthReservation

9.7.6. private_command()

The private_command() structure provides a means to distribute user-defined commands using the SCTE 35 protocol. The first bit field in each user-defined command is a 32-bit identifier, unique for each participating vendor. Receiving equipment *should* skip any splice_info_section() messages containing private_command() structures with unknown identifiers.

Table 13 - private_command()

Syntax	Bits	Mnemonic
private_command() { identifier	32	uimsbf
for(i=0; i<N; i++) { private_byte	8	uimsbf
} }		

The XML schema for private_command is shown in Figure 13.

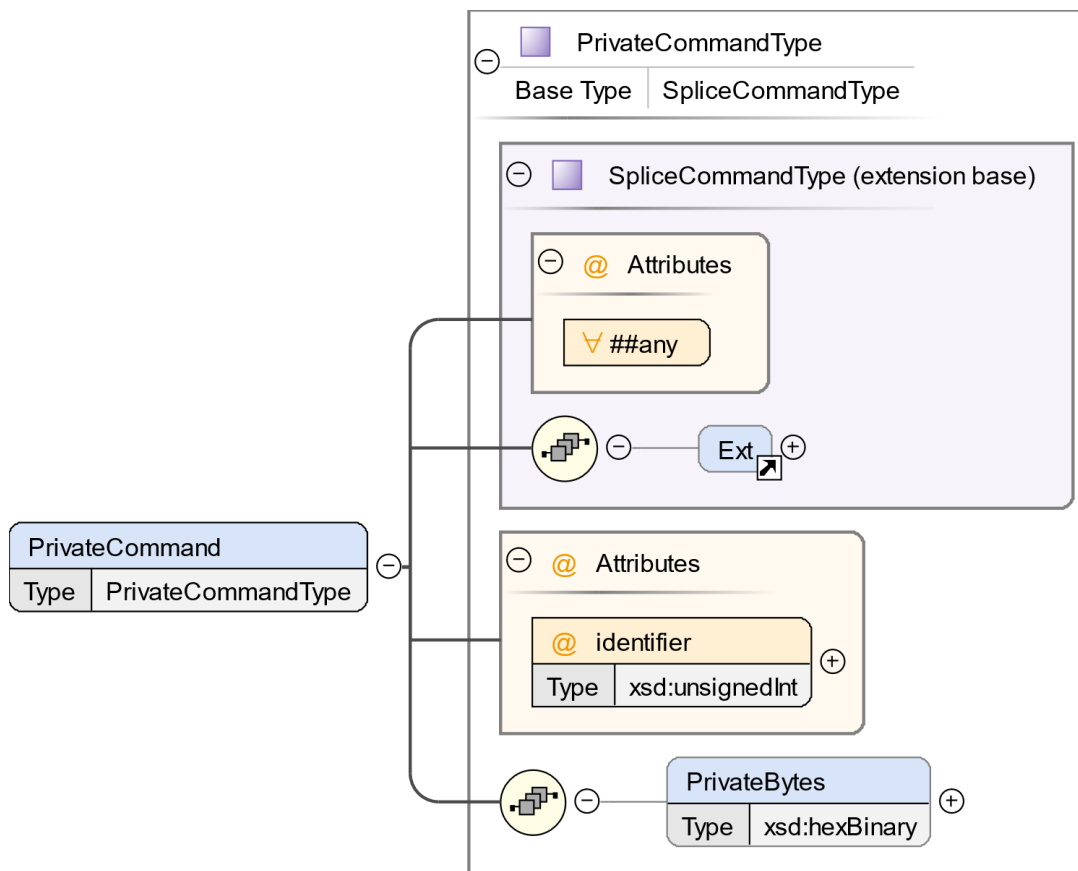

Figure 13 - PrivateCommand

identifier – The identifier is a 32-bit field as defined in ISO/IEC 13818-1 [MPEG Systems], Section 2.6.8 and 2.6.9, for the registration_descriptor() format_identifier. Only identifier values registered and recognized by SMPTE Registration Authority, LLC *should* be used (See [SMPTE RA]). Its use in the private_command() structure *shall* scope and identify only the private information contained within this command. This 32-bit number is used to identify the owner of the command.

@identifier [Optional; xsd:unsignedInt]

private_byte – The remainder of the descriptor is dedicated to data fields as required by the descriptor being defined.

PrivateBytes [Optional; xsd:hexBinary] If present, the PrivateBytes *shall* contain the hex binary representation of the private data.

Private means for communicating detailed vendor-unique ancillary information *should* be the only use of such data, and it *shall not* provide the same result as a standardized command.

9.8. Time

9.8.1. splice_time()

The splice_time() structure, when modified by pts_adjustment, specifies the time of the splice event.

Table 14 - splice_time()

Syntax	Bits	Mnemonic
splice_time() {		
time_specified_flag	1	bslbf
if(time_specified_flag == 1) {		
reserved	6	bslbf
pts_time	33	uimsbf
}		
else		
reserved	7	bslbf
}		

The XML schema for splice_time() is shown in Figure 14.

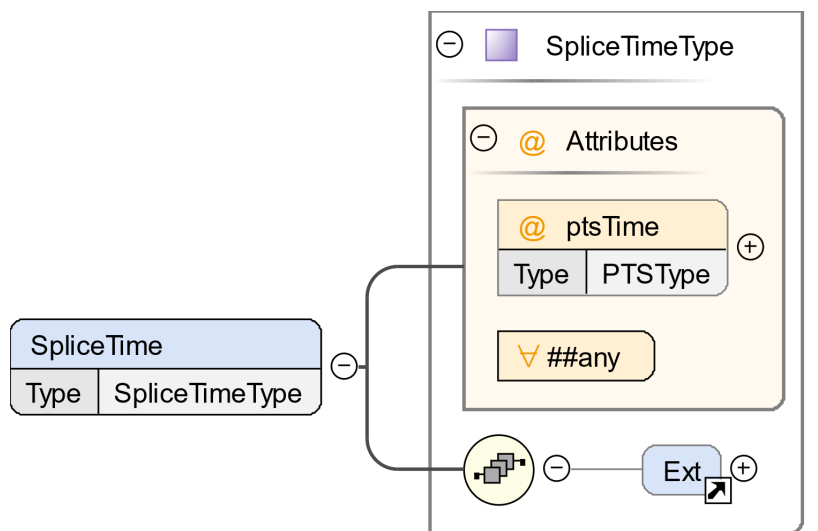

Figure 14 - SpliceTime

9.8.1.1. Semantic definition of fields in splice_time()

time_specified_flag – A 1-bit flag that, when set to ‘1’, indicates the presence of the pts_time field and associated reserved bits.

There is no entry in the XML schema for time_specified_flag. The value of time_specified_flag *shall* be set to ‘1’ when converting an XML representation of the splice_insert to Bit Stream Format if the ptsTime

attribute is present in the SpliceTime Element; otherwise, the value of time_specified_flag *shall* be set to '0'.

pts_time – A 33-bit field that indicates time in terms of ticks of the program’s 90 kHz clock. This field, when modified by pts_adjustment, represents the time of the intended Splice Point. The Splice Point *shall* be the first PES packet in the bit stream with a PTS time greater than or equal to the pts_time as adjusted by pts_adjustment. Coding constraints for Splice Points are documented in [SCTE 172].

@ptsTime [Optional; PTSType] See Section 13.2 for a description of PTSType.

9.8.2. break_duration()

The break_duration() structure specifies the duration of the commercial Break(s). It *may* be used to give the splicer an indication of when the Break will be over and when the network In Point will occur.

Table 15 - break_duration()

Syntax	Bits	Mnemonic
break_duration() {		
auto_return	1	bslbf
reserved	6	bslbf
duration	33	uimsbf
}		

The XML schema for break_duration() is shown in Figure 15.

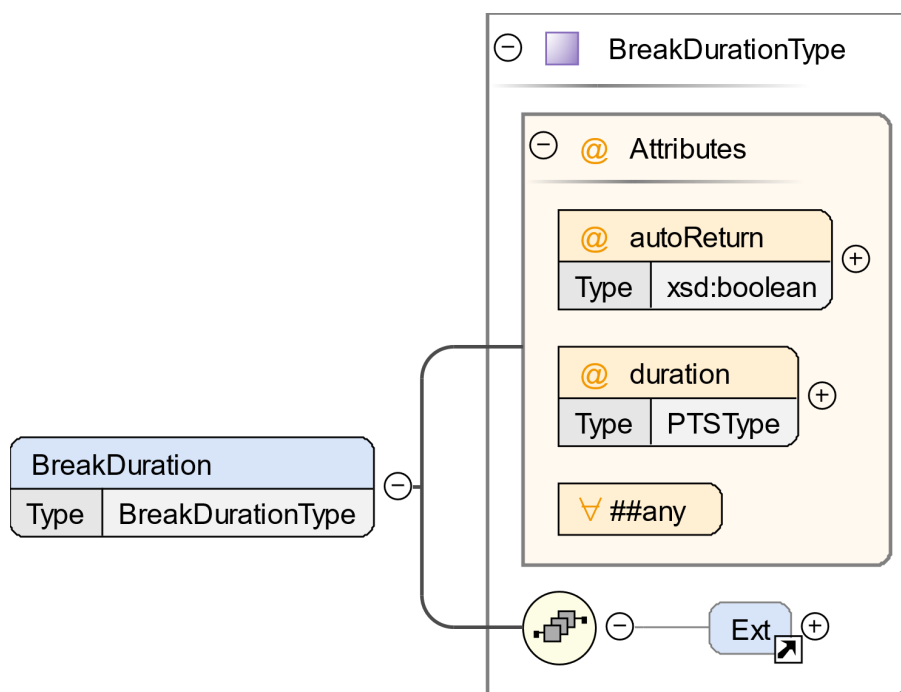

Figure 15 - BreakDuration

9.8.2.1. Semantic definition of fields in break_duration()

auto_return – A 1-bit flag that, when set to ‘1’, denotes that the duration *shall* be used by the splicing device to know when the return to the network feed (end of Break) is to take place. A splice_insert() command with out_of_network_indicator set to 0 is not intended to be sent to end this Break. When this flag is ‘0’, the duration field, if present, is not required to end the Break because a new splice_insert() command will be sent to end the Break. In this case, the presence of the break_duration field acts as a safety mechanism in the event that a splice_insert() command is lost at the end of a Break.

@autoReturn [Required; xsd:boolean]

duration – A 33-bit field that indicates elapsed time in terms of ticks of the program’s 90 kHz clock.

@duration [Required; PTSType] See Section 13.2 for a description of PTSType.

9.9. Constraints

9.9.1. Constraints on splice_info_section()

The splice_info_section *shall* be carried in one or more PID stream(s) that are specific to a program and referred to in the PMT. The splice_info_section PID(s) *shall* be identified in the PMT by stream_type equal to 0x86.

The splice_info_section carried in one or more PID stream(s) referenced in a program’s PMT *shall* contain only information about splice events that occur in that program.

A splice event *shall* be defined by a single event_id (see splice_insert() splice_event_id, splice_schedule splice_event_id or time_signal() with segmentation_descriptor segmentation_event_id).

Component Splice Mode is *deprecated*.

If the Component Splice Mode will be used, then each elementary PID stream *shall* be identified by a stream_identifier_descriptor carried in the PMT loop, one for each PID. The stream_identifier_descriptor *shall* carry a component_tag, which uniquely corresponds to one PID stream among those contained within a program and listed in the PMT for that program.

Event id values do not need to be sent in an incrementing order in subsequent messages nor must they increment chronologically. Event id values *should* comply with the constraints in section 9.9.3.

Any splice_event_id that is sent in a splice_info_section using a splice_schedule() command *shall* be sent again prior to the event using a splice_insert() command. Hence, there *shall* be a correspondence between the splice_event_id values chosen for particular events signaled by the splice_schedule() command (distant future) and splice_event_id values utilized in the splice_insert() command (near future) to indicate the same events.

When utilizing the splice_schedule() command, splice_event_id values *shall* be unique over the period of the splice_schedule() command. A splice_event_id value *may* be re-used when its associated splice time has passed.

When the splice_immediate_flag is set to 1 in the splice_insert() command, the time to splice *shall* be interpreted as the current time. This is called the “Splice Immediate Mode”. When this form is used with the splice_insert() command, the splice *may* occur at the nearest (prior or subsequent) opportunity that is

detected by the splicer. The “Splice Immediate Mode” *may* be used for both splicing entry and exit points, i.e. for both states of out_of_network_indicator.

It **shall** be allowed that any avail *may* be ended with a Program Splice Mode message, a Component Splice Mode message or no message (whereby the break_duration is reached), regardless of the nature of the message at the beginning of the avail.

9.9.2. Constraints on the interpretation of time

9.9.2.1. Constraints on splice_time() for splice_insert()

For splice_command_type equal to 0x05 (splice_insert()), the following constraints on splice_time() **shall** apply:

At least one message for a network Out Point **shall** arrive at least 4 seconds in advance of the signaled splice time (pts_time as modified by pts_adjustment) if the time is specified. A Splice Immediate Mode message is allowed for a network Out Point, but the actual splice time is not defined and it is recommended that Splice Immediate Mode messages only be used for the early termination of Breaks. When non-Splice Immediate Mode cue messages are used for network In Points, the cue message **shall** arrive at the splicer before the arrival of the signaled In Point picture at the receiver.

An Out Point lies between two presentation units. The intended Out Point of a signaled splice event **shall** be before the first presentation unit with a presentation time greater than or equal to the signaled pts_time as modified by pts_adjustment.

An In Point lies between two presentation units. The intended In Point of a signaled splice event **shall** be the first presentation unit with a presentation time greater than or equal to the signaled pts_time as modified by pts_adjustment.

Component Splice Mode is *deprecated*.

When the Component Splice Mode is in effect and the out_of_network_indicator is ‘1’ (the beginning of a Break), each component listed in the splice_insert() component loop **shall** be switched from the network component to the splicer supplied component at the time indicated. Components not listed in the component loop of the message will remain unchanged: if a splicer output component was the network component then it will remain the network component; if a splicer output component was the splicer supplied component then it will remain the splicer supplied component.

When the Component Splice Mode is in effect and the out_of_network_indicator is ‘0’ (the end of a Break), each component listed in the splice_insert() component loop **shall** be switched from the splicer supplied component to the network component at the time indicated. Components not listed in the component loop of the message will remain unchanged: if a splicer output component was the network component then it will remain the network component; if a splicer output component was the splicer supplied component then it will remain the splicer supplied component.

When the Component Splice Mode is in effect and the Splice Immediate Mode is not in effect, the first component listed in the component loop of the splice_insert() command **shall** have a valid pts_time in its associated splice_time() and this pts_time is referred to as the default pts_time. Subsequent components listed in the component loop of the same message, which don’t have an associated pts_time, **shall** utilize this default pts_time. It **shall** be allowed that any and all components following the first listed component of a splice_insert() command *may* contain a unique pts_time that is different from the default pts_time.

In the Component Splice Mode, all pts_time values given in the splice_insert component loop *shall* be modified by the pts_adjustment field to obtain each intended value for the signaled Out Point or In Point. The pts_adjustment, provided by any device that generates or modifies a pts_adjustment field value, *shall* apply to all pts_time fields in the message.

9.9.2.2. Constraints on break_duration() for splice_insert()

For splice_command_type equal to 0x05 (insert) the following constraints on break_duration() *shall* apply:

The value given in break_duration() is interpreted as the intended duration of the commercial Break. It is an optional field to be used when the out_of_network_indicator equals 1. It *may* be used in the same splice_insert() command that specifies the start time of the Break, so that the splicer can calculate the time when the Break will be over.

Breaks *may* be terminated by issuing a splice_insert() command with out_of_network_indicator set to 0. A splice_time() *may* be given or the Splice Immediate Mode *may* be used. When a break_duration was given at the start of the Break (where the auto_return was set to zero), the break_duration value *may* be utilized as a backup mechanism for ensuring that a return to the network actually happens in the event of a lost cueing packet.

Breaks *may* also be terminated by giving a Break duration at the beginning of a Break and relying on the splicing device to return to the network feed at the proper time. The auto_return flag *shall* be 1. This will be referred to as the Auto Return Mode. Auto Return Mode Breaks do not require and do not disallow cue messages at the end of the Break with out_of_network_indicator set to 0. Hence, a receiving device *should not* expect a cue message at the end of a Break in order to function properly. Auto Return Mode Breaks *may* however be terminated early. To end the Break prematurely, a second splice_insert() command *may* be given, where the out_of_network_indicator equals 0. The new time of the back to network splice *may* be given by an updated splice_time(), or the Splice Immediate Mode message *may* be used. A cue message with out_of_network_indicator set to 0 *shall* always override the duration field of a previous cue message (with out_of_network_indicator set to 1) if that Break's signaled duration is still under way.

9.9.3. Constraints on Event Id

This section applies to the splice_event_id value in the splice_insert() and splice_schedule() command. It also applies to the segmentation_event_id value carried in the segmentation_descriptor with a time_signal() command.

Only one occurrence of a given event id value *shall* be active at any one time. While active, an event id value *shall not* be used to identify other events. Once an event ends the event id value then becomes inactive and *shall* be eligible for use. Event id values *shall not* be reused immediately if there are multiple messages referencing the same Splice Point in the Transport Stream that end some events and start new events. See Section 10.3.3.7 for additional details on event id values in segmentation_descriptor().

The 32-bit event id value *shall* be partitioned in the following way to allow each source to manage the event id values generated:

Syntax	Bits	Type
<i>Event source</i>	4	uimsbf

<i>Event number</i>	28	uimsbf
---------------------	----	--------

Event_source – A user assigned number for the source of the Cue Message.

Event_number – A number chosen by the Event source to identify an instance of the Cue Message.

The following values for *Event_source* **shall** be utilized:

Source of Cue Message	Event_source Value	Event id ranges
Cue embedded in original source material by network programming systems.	0	0x00000000, 0x00000001 0x0fffffff
Cue created by automation system switching	4	0x40000000, 0x40000001 0x4fffffff
Cue created by manual event trigger system	6	0x60000000, 0x60000001 0x6fffffff
Cue created by local content replacement system	12	0xC0000000, 0xC0000001 0xCfffffff

See SCTE 67 for additional information on systems that participate in the content delivery distribution system.

The `splice_insert()` command, `splice_schedule()` command and `segmentation_descriptor` in a `time_signal()` command include a flag to indicate to systems receiving a command to determine compliance with these constraints.

10. Splice Descriptors

10.1. Overview

The `splice_descriptor` is a prototype for adding new fields to the `splice_info_section`. All descriptors included use the same syntax for the first six bytes. In order to allow private information to be added, the ‘identifier’ code is available. This removes the need for a registration descriptor in the descriptor loop.

Any receiving equipment *should* skip any descriptors with unknown identifiers or unknown descriptor tags. For descriptors with known identifiers, the receiving equipment *should* skip descriptors with an unknown `splice_descriptor_tag`.

Splice descriptors *may* exist in the `splice_info_section` for extensions specific to the various commands.

Table 16 lists the defined Splice Descriptor Tags. Both the tag values that **shall** be used for Bit Stream Format as well as the XML Element that **shall** be used to identify each specific Splice Descriptor are listed.

Implementers note: Multiple descriptors of the same or different types in a single command are allowed and *may* be common. One case of multiple `segmentation_descriptors` is described in Section 10.3.3.2. The only limit on the number of descriptors is the `section_length` in Table 5, although there *may* be other practical or implementation limits.

Table 16 - Splice Descriptor Tags

Tag	XML Element	Descriptors for Identifier “CUEI”
0x00	AvailDescriptor	avail_descriptor
0x01	DTMFDescriptor	DTMF_descriptor
0x02	SegmentationDescriptor	segmentation_descriptor
0x03	TimeDescriptor	time_descriptor
0x04	AudioDescriptor	audio_descriptor
0x05 – 0xEF		Reserved for future SCTE splice_descriptors
0xF0 – 0xFF		Reserved for DVB use

Note: DVB use as specified in [ETSI 103 752-1]

10.2. Splice descriptor

The Splice Descriptor syntax provided in this section is to be used as a template for specific implementations of a descriptor intended for the splice_info_section. It *should* be noted that splice descriptors are only used within a splice_info_section. They are not to be used within MPEG syntax, such as the PMT, or in the syntax of any other standard. This allows one to draw on the entire range of descriptor tags when defining new descriptors.

Table 17 - splice_descriptor()

Syntax	Bits	Mnemonic
splice_descriptor() {		
splice_descriptor_tag	8	uimsbf
descriptor_length	8	uimsbf
identifier	32	uimsbf
for(i=0; i<N; i++) {		
private_byte	8	uimsbf
}		
}		

The XML schema base type for all Splice Descriptors is SpliceDescriptorType. The XML schema for the SpliceDescriptorType base type is shown in Figure 16. The optional extension element is the only element defined within the base type.

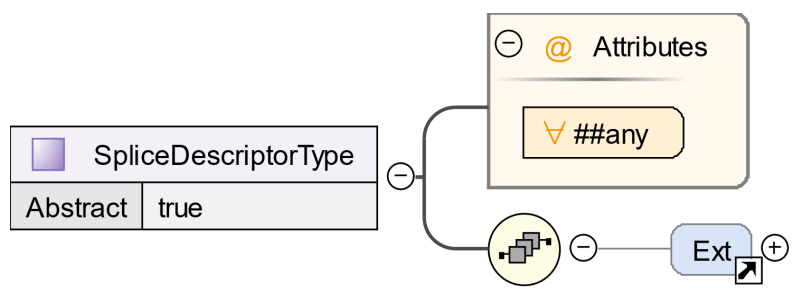

Figure 16 - SpliceDescriptorType

10.2.1. Semantic definition of fields in splice_descriptor()

splice_descriptor_tag – This 8-bit number defines the syntax for the private bytes that make up the body of this descriptor. The descriptor tags are defined by the owner of the descriptor, as registered using the identifier.

There is no entry in the XML schema for `splice_descriptor_tag`. The value is implicit when transforming to or from an XML representation of the `splice_descriptor()` based on the specific descriptor Element supplied. The Element names can be found in the XML Element in Table 16.

descriptor_length – This 8-bit number gives the length, in bytes, of the descriptor following this field. Descriptors are limited to 256 bytes, so this value is limited to 254. Since some descriptors have optional elements, care should be used while decoding a descriptor to never attempt to decode beyond the descriptor length.

There is no entry in the XML schema for `descriptor_length`. The value *shall* be derived when converting an XML representation of the specific `splice_descriptor()` to Bit Stream Format.

identifier – The identifier is a 32-bit field as defined in ISO/IEC 13818-1 [MPEG Systems], Section 2.6.8 and 2.6.9, for the `registration_descriptor()` `format_identifier`. Only identifier values registered and recognized by SMPTE Registration Authority, LLC *should* be used (See [SMPTE RA]). Its use in this descriptor *shall* scope and identify only the private information contained within this descriptor. This 32-bit number is used to identify the owner of the descriptor. The code 0x43554549 (ASCII “CUEI”) for descriptors defined in this specification has been registered with SMPTE.

There is no entry in the XML schema for `identifier`.

private_byte – The remainder of the descriptor is dedicated to data fields as required by the descriptor being defined.

There is no entry in the XML schema for `private_byte`.

10.2.2. Private Splice Descriptors

Private Splice Descriptors, defined external to this specification, may be included in the `splice_info` section. When present, they *shall* conform to the format defined for `splice_descriptor`, above, with the following additional constraints.

The XML schema base type for all Private Splice Descriptors is `PrivateDescriptorType`.

The XML schema for PrivateDescriptorType is shown in Figure 17.

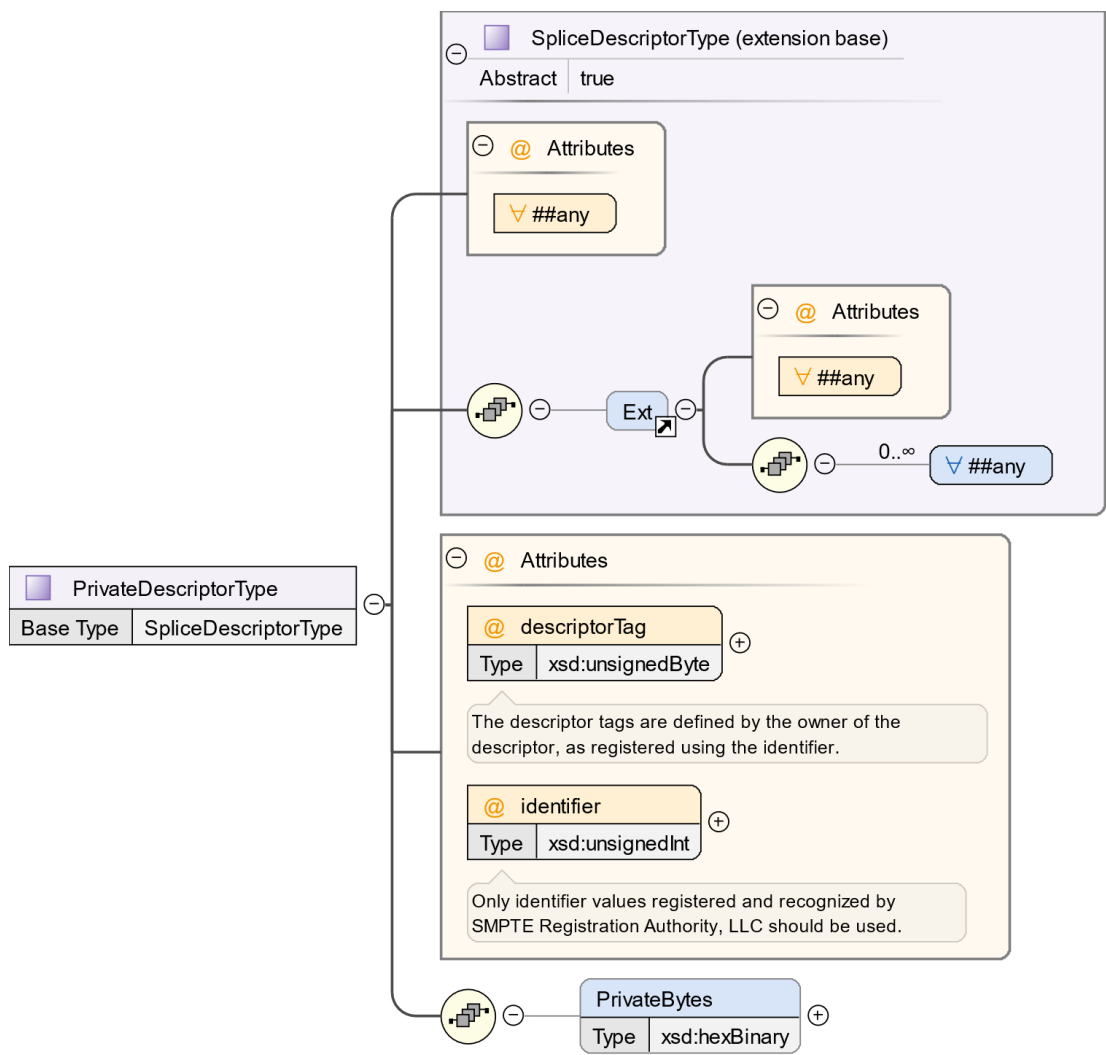

Figure 17 - PrivateDescriptorType

splice_descriptor_tag – This 8-bit number defines the syntax for the private bytes that make up the body of this descriptor. The descriptor tags are defined by the owner of the descriptor, as registered using the identifier.

@descriptorTag[required; xsd:unsignedByte]

identifier – The code 0x43554549 (ASCII “CUEI”) *shall not* be used for Private Descriptors.

@identifier[required; xsd:unsignedInt]

private_bytes – body of the Private Descriptor.

@PrivateBytes[optional; xsd:hexBinary]

10.3. Specific splice descriptors

10.3.1. avail_descriptor()

The avail_descriptor is an implementation of a splice_descriptor. It provides an optional extension to the splice_insert() command that allows an authorization identifier to be sent for an avail. Multiple copies of this descriptor *may* be included by using the loop mechanism provided. This identifier is intended to replicate the functionality of the cue tone system used in analog systems for ad insertion. This descriptor is intended only for use with a splice_insert() command, within a splice_info_section.

Table 18 - avail_descriptor()

Syntax	Bits	Mnemonic
avail_descriptor() {		
splice_descriptor_tag	8	uimsbf
descriptor_length	8	uimsbf
identifier	32	uimsbf
provider_avail_id	32	uimsbf
}		

The XML schema for avail_descriptor() is shown in Figure 18.

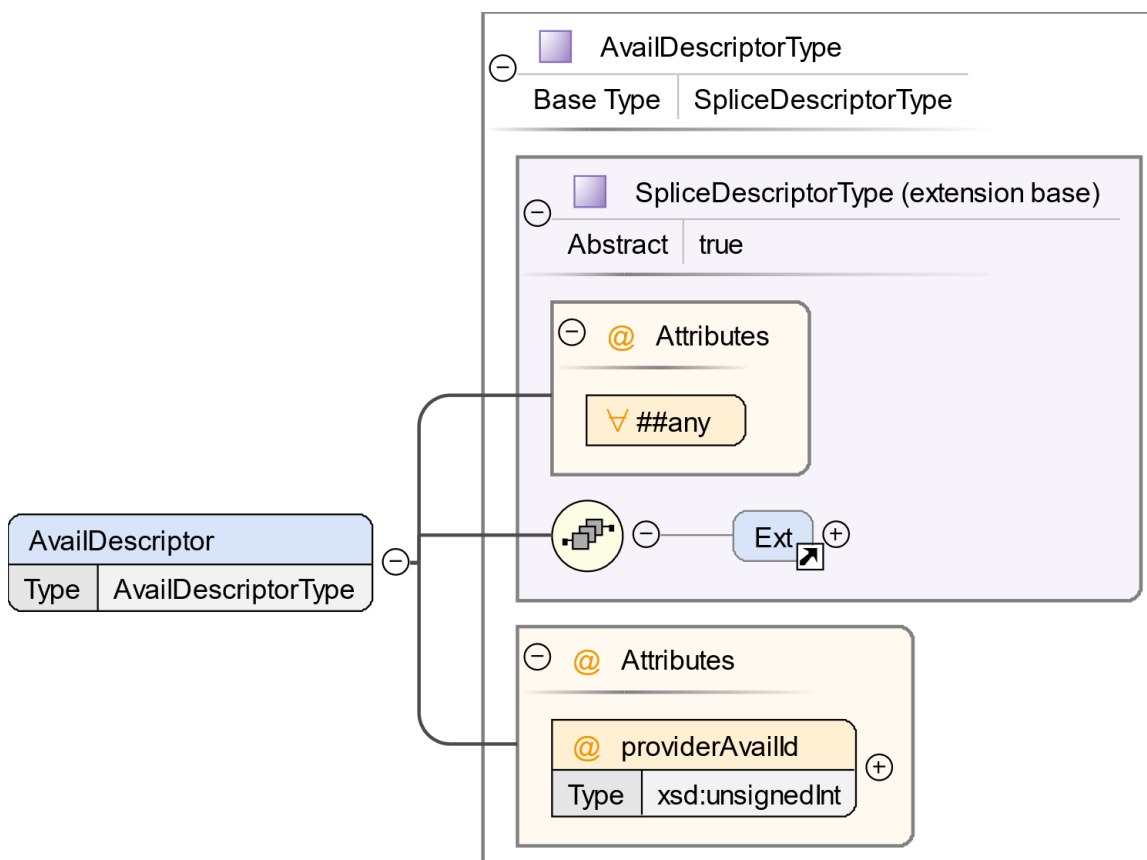

Figure 18 - AvailDescriptor

10.3.1.1. Semantic definition of fields in avail_descriptor()

splice_descriptor_tag – This 8-bit number defines the syntax for the private bytes that make up the body of this descriptor. The splice_descriptor_tag *shall* have a value of 0x00.

There is no entry in the XML schema for splice_descriptor_tag. The value is set to 0x00 when transforming from an XML representation of the avail_descriptor() to Bit Stream Format.

descriptor_length – This 8-bit number gives the length, in bytes, of the descriptor following this field. The descriptor_length field *shall* have a value of 0x08.

There is no entry in the XML schema for descriptor_length. The value *shall* be derived when converting an XML representation of the avail_descriptor() to Bit Stream Format.

identifier – This 32-bit number is used to identify the owner of the descriptor. The identifier *shall* have a value of 0x43554549 (ASCII “CUEP”).

There is no entry in the XML schema for identifier.

provider_avail_id – This 32-bit number provides information that a receiving device *may* utilize to alter its behavior during or outside of an avail. It *may* be used in a manner similar to analog cue tones. An example would be a network directing an affiliate or a head-end to black out a sporting event.

@providerAvailId [Required; xsd:unsignedInt]

10.3.2. DTMF_descriptor()

The DTMF_descriptor() is an implementation of a splice_descriptor. It provides an optional extension to the splice_insert() command that allows a receiver device to generate a legacy analog DTMF sequence based on a splice_info_section being received.

Table 19 - DTMF_descriptor()

Syntax	Bits	Mnemonic
DTMF_descriptor() {		
splice_descriptor_tag	8	uimsbf
descriptor_length	8	uimsbf
identifier	32	uimsbf
preroll	8	uimsbf
dtmf_count	3	uimsbf
reserved	5	bslbf
for(i=0; i< dtmf_count ; i++) {		
DTMF_char	8	uimsbf
}		
}		

The XML schema for DTMF_descriptor() is shown in Figure 19.

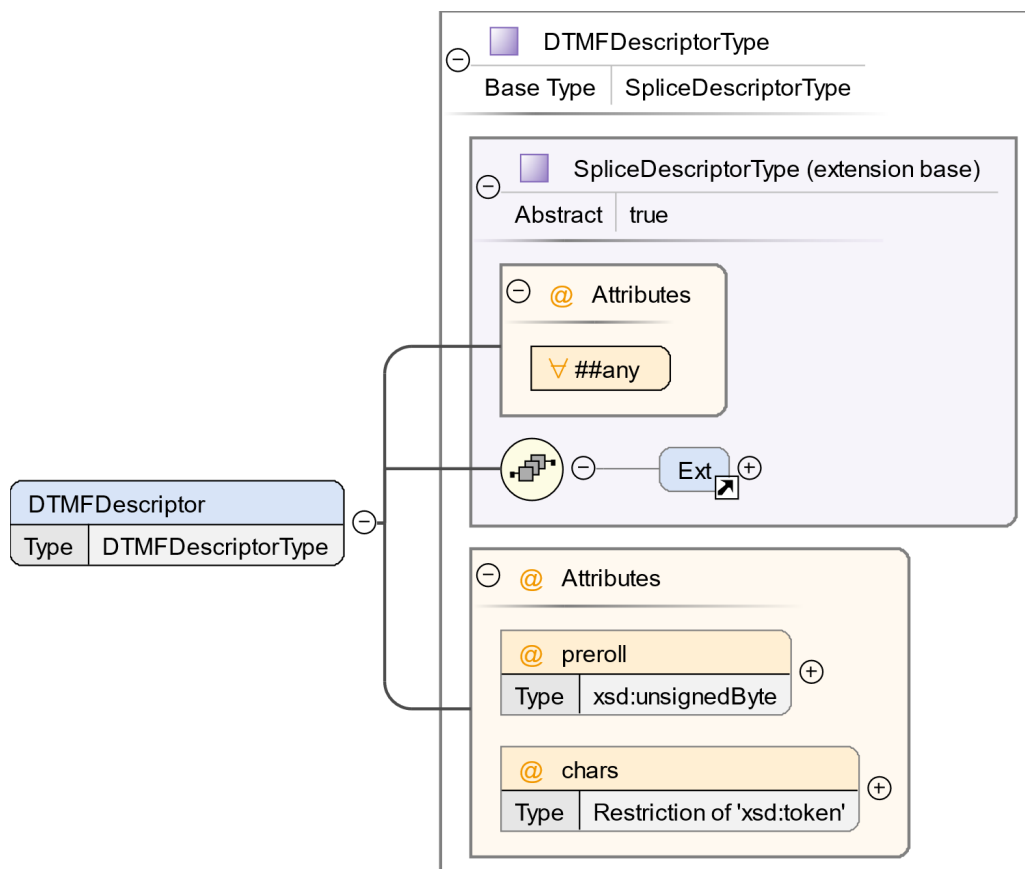

Figure 19 - DTMFDescriptor

10.3.2.1. Semantic definition of fields in DTMF_descriptor()

splice_descriptor_tag – This 8-bit number defines the syntax for the private bytes that make up the body of this descriptor. The splice_descriptor_tag *shall* have a value of 0x01.

There is no entry in the XML schema for splice_descriptor_tag. The value is set to 0x01 when transforming from an XML representation of the DTMF_descriptor() to Bit Stream Format.

descriptor_length – This 8-bit number gives the length, in bytes, of the descriptor following this field.

There is no entry in the XML schema for descriptor_length. The value *shall* be derived when converting an XML representation of the DTMF_descriptor() to Bit Stream Format.

identifier – This 32-bit number is used to identify the owner of the descriptor. The identifier *shall* have a value of 0x43554549 (ASCII “CUEI”).

There is no entry in the XML schema for identifier.

preroll – This 8-bit number is the time the DTMF is presented to the analog output of the device in tenths of seconds. This gives a pre-roll range of 0 to 25.5 seconds. The splice info section *shall* be sent at least two seconds earlier than this value. The minimum suggested pre-roll is 4.0 seconds.

@preroll [Optional; xsd:unsignedByte]

dtmf_count – This value of this flag is the number of DTMF characters the device is to generate.

There is no entry in the XML schema for dtmf_count. The value *shall* be derived when converting an XML representation of the DTMF_descriptor() to Bit Stream Format based on the number of chars in @chars.

DTMF_char – This is an ASCII value for the numerals ‘0’ to ‘9’, ‘*’, ‘#’. The device *shall* use these values to generate a DTMF sequence to be output on an analog output. The sequence *shall* complete with the last character sent being the timing mark for the pre-roll.

@chars [Optional; xsd:token]

10.3.3. segmentation_descriptor()

The segmentation_descriptor() is an implementation of a splice_descriptor(). It provides an optional extension to the time_signal() and splice_insert() commands that allows for segmentation messages to be sent in a time/video accurate method. This descriptor *shall* only be used with the time_signal(), splice_insert() and the splice_null() commands. The time_signal() or splice_insert() message *should* be sent at least once a minimum of 4 seconds in advance of the signaled splice_time() to permit the insertion device to place the splice_info_section() accurately.

Devices that do not recognize a value in any field *shall* ignore the message and take no action.

Table 20 - segmentation_descriptor()

Syntax	Bits	Mnemonic
segmentation_descriptor() {		
splice_descriptor_tag	8	uimsbf
descriptor_length	8	uimsbf
identifier	32	uimsbf
segmentation_event_id	32	uimsbf
segmentation_event_cancel_indicator	1	bslbf
segmentation_event_id_compliance_indicator	1	bslbf
reserved	6	bslbf
if(segmentation_event_cancel_indicator == ‘0’) {		
program_segmentation_flag	1	bslbf
segmentation_duration_flag	1	bslbf
delivery_not_restricted_flag	1	bslbf
if(delivery_not_restricted_flag == ‘0’) {		
web_delivery_allowed_flag	1	bslbf
no_regional_blackout_flag	1	bslbf
archive_allowed_flag	1	bslbf
device_restrictions	2	bslbf
} else {		
reserved	5	bslbf
}		

if(program_segmentation_flag == '0') { ⁵		
component_count	8	uimsbf
for(i=0;i<component_count;i++) {		
component_tag	8	uimsbf
reserved	7	bslbf
pts_offset	33	uimsbf
}		
}		
if(segmentation_duration_flag == '1')		
segmentation_duration	40	uimsbf
segmentation_upid_type	8	uimsbf
segmentation_upid_length	8	uimsbf
segmentation_upid()		
segmentation_type_id	8	uimsbf
segment_num	8	uimsbf
segments_expected	8	uimsbf
if(segmentation_type_id == '0x34'		
segmentation_type_id == '0x30' 		
segmentation_type_id == '0x32' 		
segmentation_type_id == '0x36' 		
segmentation_type_id == '0x38' 	8	uimsbf
segmentation_type_id == '0x3A' 		
segmentation_type_id == '0x44' 		
segmentation_type_id == '0x46') {		
sub_segment_num		
sub_segments_expected	8	uimsbf
}		
}		
}		

⁵ Component Splice Mode is deprecated.

The XML schema representation of the Segmentation Descriptor is specified in Figure 20. Component Splice Mode is *deprecated*.

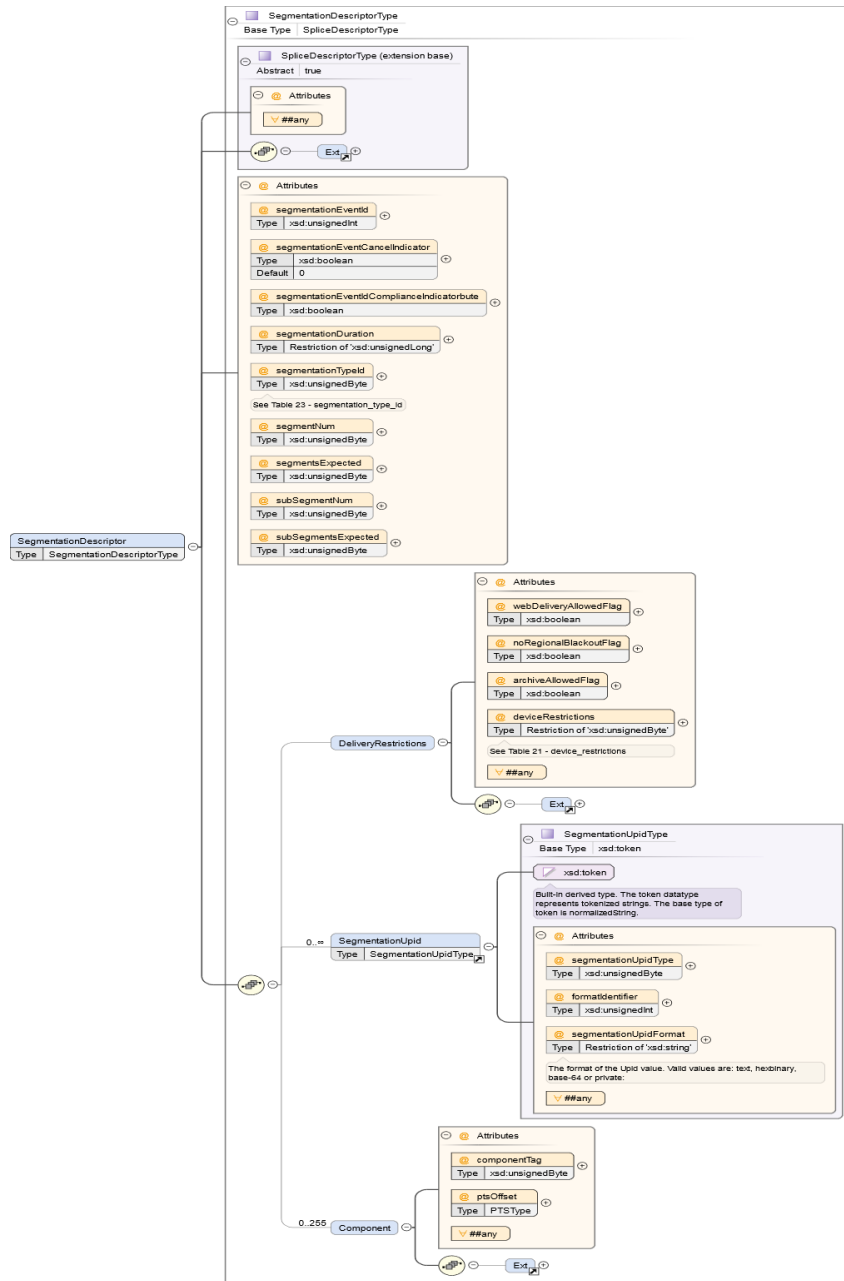

Figure 20 - SegmentationDescriptorType

NOTE:

Component Splice Mode is *deprecated*. The Component Element *should not* be utilized.

10.3.3.1. Segmentation descriptor details

Semantic definition of fields in segmentation_descriptor() as shown.

splice_descriptor_tag – This 8-bit number defines the syntax for the private bytes that make up the body of this descriptor. The splice_descriptor_tag *shall* have a value of 0x02.

There is no entry in the XML schema for splice_descriptor_tag. The value is set to 0x02 when transforming from an XML representation of the segmentation_descriptor() to Bit Stream Format.

descriptor_length – This 8-bit number gives the length, in bytes, of the descriptor following this field.

Note: sub_segment_num and sub_segments_expected can form an optional appendix to the segmentation descriptor. The presence or absence of this optional data block is determined by the descriptor loop's descriptor_length.

There is no entry in the XML schema for descriptor_length. The value *shall* be derived when converting an XML representation of the segmentation_descriptor() to Bit Stream Format.

identifier – This 32-bit number is used to identify the owner of the descriptor. The identifier *shall* have a value of 0x43554549 (ASCII “CUEI”).

There is no entry in the XML schema for identifier.

segmentation_event_id – A 32-bit unique segmentation event identifier. Only one occurrence of a given segmentation_event_id value *shall* be active at any one time. See discussion in Section 10.3.3.7, Segmenting Content - Additional semantics (below).

@segmentationEventId [Optional; xsd:unsignedInt]

segmentation_event_cancel_indicator – A 1-bit flag that, when set to ‘1’, indicates that a previously sent segmentation event, identified by segmentation_event_id, has been cancelled. The segmentation_type_id does not need to match between the original/cancelled segmentation event message and the message with the segmentation_event_cancel_indicator true. Once a segmentation event is cancelled, the segmentation_event_id *may* be reused for content identification or to start a new Segment.

@segmentationEventCancelIndicator [Optional; xsd:Boolean] A value of TRUE *shall* be equivalent to a value of ‘1’ and FALSE *shall* be equivalent to a value of ‘0’. If omitted, set segmentation_event_cancel_indicator to 0 when generating a segmentation_descriptor().

segmentation_event_id_compliance_indicator - A 1-bit flag that, when set to ‘0’, indicates that the segmentation_event_id is compliant with section 9.9.3. When this flag is '1', compliance with section 9.9.3 is not specified.

@segmentationEventIdComplianceIndicator [Optional; xsd:boolean] When present and set to “true”, it indicates that the @segmentationEventId value complies with section 9.9.3. Otherwise, set to “false” or omit.

program_segmentation_flag – A 1-bit flag that *should* be set to ‘1’ indicating that the message refers to a Program Segmentation Point and that the mode is the Program Segmentation Mode whereby all PIDs/components of the program are to be segmented.

Component Splice Mode is *deprecated*.

When set to '0', this field indicates that the mode is the Component Segmentation Mode whereby each component that is intended to be segmented will be listed separately by the syntax that follows.

The `program_segmentation_flag` can be set to different states during different descriptors messages within a program.

There is no entry in the XML schema for `program_segmentation_flag`. The value of `program_segmentation_flag` *shall* be set to '1' when converting an XML representation of the `segmentation_descriptor()` to Bit Stream Format if there are no Component Elements present in the SegmentationDescriptor Element; otherwise, the value of `program_segmentation_flag` *shall* be set to '0'. (Component Splice Mode is *deprecated*.)

segmentation_duration_flag – A 1-bit flag that *should* be set to '1' indicating the presence of `segmentation_duration` field. The accuracy of the start time of this duration is constrained by the `splice_command_type` specified. For example, if a `splice_null()` command is specified, the precise position in the stream is not deterministic.

There is no entry in the XML schema for `segmentation_duration_flag`. The value of `segmentation_duration_flag` *shall* be set to '1' when converting an XML representation of the `segmentation_descriptor()` to Bit Stream Format if the `segmentationDuration` Attribute is specified; otherwise, the value of `segmentation_duration_flag` *shall* be set to '0'.

delivery_not_restricted_flag – When this bit has a value of '1', the next five bits are reserved. When this bit has the value of '0', the following additional information bits *shall* have the meanings defined below. This bit and the following five bits are provided to facilitate implementations that use methods that are out of scope of this standard to process and manage this Segment.

There is no entry in the XML schema for `delivery_not_restricted_flag`. The value of `delivery_not_restricted_flag` *shall* be set to '0' when converting an XML representation of the `segmentation_descriptor()` to Bit Stream Format if the `DeliveryRestrictions` Element is specified; otherwise, the value of `delivery_not_restricted_flag` *shall* be set to '1'.

web_delivery_allowed_flag – This bit *shall* have the value of '1' when there are no restrictions with respect to web delivery of this Segment. This bit *shall* have the value of '0' to signal that restrictions related to web delivery of this Segment are asserted.

@webDeliveryAllowedFlag [Conditional Mandatory; xsd:boolean] The `webDeliveryAllowedFlag` *shall* be specified if the `DeliveryRestrictions` Element is specified.

no_regional_blackout_flag – This bit *shall* have the value of '1' when there is no regional blackout of this Segment. This bit *shall* have the value of '0' when this Segment is restricted due to regional blackout rules.

@noRegionalBlackoutFlag [Conditional Mandatory; xsd:boolean] The `noRegionalBlackoutFlag` *shall* be specified if the `DeliveryRestrictions` Element is specified.

archive_allowed_flag – This bit *shall* have the value of '1' when there is no assertion about recording this Segment. This bit *shall* have the value of 0 to signal that restrictions related to recording this Segment are asserted.

@archiveAllowedFlag [Conditional Mandatory; xsd:boolean] The archiveAllowedFlag *shall* be specified if the DeliveryRestrictions Element is specified.

device_restrictions – See Table 21 for the meaning of this syntax element. This field signals three pre-defined groups of devices. The population of each group is independent and the groups are non-hierarchical. The delivery and format of the messaging to define the devices contained in the groups is out of the scope of this standard.

Table 21 - device_restrictions

Segmentation Message	device_restrictions
Restrict Group 0	00
Restrict Group 1	01
Restrict Group 2	10
None	11

Restrict Group 0 – This Segment is restricted for a class of devices defined by an out of band message that describes which devices are excluded.

Restrict Group 1 – This Segment is restricted for a class of devices defined by an out of band message that describes which devices are excluded.

Restrict Group 2 – This Segment is restricted for a class of devices defined by an out of band message that describes which devices are excluded.

None – This Segment has no device restrictions.

@deviceRestrictions [Conditional Mandatory; xsd:unsignedByte] The deviceRestrictions *shall* be specified if the DeliveryRestrictions Element is specified.

component_count (Component Splice Mode *deprecated*) – An 8-bit unsigned integer that specifies the number of instances of elementary PID stream data in the loop that follows. Components are equivalent to elementary PID streams. If program_segmentation_flag == ‘0’ then the value of component_count *shall* be greater than or equal to 1.

There is no entry in the XML schema for component_count. For Component Splice Mode, the value *shall* be derived when converting an XML representation of the segmentation_descriptor() to Bit Stream Format. Component_count *shall* be set to the count of Component Elements supplied within the SegmentationDescriptor Element in the XML document.

component_tag (Component Splice Mode *deprecated*) – An 8-bit value that identifies the elementary PID stream containing the Segmentation Point specified by the value of splice_time() that follows. The value *shall* be the same as the value used in the stream_identifier_descriptor() to identify that elementary PID stream. The presence of this field from the component loop denotes the presence of this component of the asset.

@componentTag [Required, xsd:unsignedByte]

pts_offset – A 33-bit unsigned integer that *shall* be used by a splicing device as an offset to be added to the pts_time, as modified by pts_adjustment, in the time_signal() message to obtain the intended splice time(s). When this field has a zero value, then the pts_time field(s) *shall* be used without an offset. If

splice_time() time_specified_flag = 0 or if the command this descriptor is carried with does not have a splice_time() field, this field **shall** be used to offset the derived immediate splice time.

@ptsOffset [Required, PTSType] (see Section 13.2).

segmentation_duration – A 40-bit unsigned integer that specifies the duration of the Segment in terms of ticks of the program’s 90 kHz clock. It *may* be used to give the splicer an indication of when the Segment will be over and when the next segmentation message will occur. **Shall** be 0 for end messages.

@segmentationDuration [Optional; xsd:unsignedLong]

segmentation_upid_type – A value from Table 22. There are multiple types allowed to ensure that programmers will be able to use an id that their systems support. It is expected that the consumers of these ids will have an out-of-band method of collecting other data related to these numbers and therefore they do not need to be of identical types. These ids *may* be in other descriptors in the Program and, where the same identifier is used (ISAN for example), it **shall** match between Programs.

Table 22 - segmentation_upid_type

segmentation_upid_type	segmentation_upid_length (Bytes)	segmentation_upid() (Name)	Description	Example Textual Representation
0x00	0	Not Used	The segmentation_upid is not defined and is not present in the descriptor.	
0x01	variable	User Defined	<i>Deprecated:</i> use type 0x0C; The segmentation_upid does not follow a standard naming scheme.	User Defined
0x02	8	ISCI	<i>Deprecated:</i> use type 0x03, 8 characters; 4 alpha characters followed by 4 numbers.	ABCD1234
0x03	12	Ad-ID	Defined by the Advertising Digital Identification, LLC group. 12 characters; 4 alpha characters (company identification prefix) followed by 8 alphanumeric characters. (See [Ad-ID])	ABCD0001000H [SMPTE 2092-1]
0x04	32	UMID	See [SMPTE 330]	060A2B34.01010105.01010D20.13000000.D2C9036C.8F195343.AB7014D2.D718BFDA
0x05	8	ISAN	<i>Deprecated:</i> use type 0x06, ISO 15706 binary encoding.	n/a
0x06	12	ISAN	Formerly known as V-ISAN. ISO 15706-2 binary encoding (“versioned” ISAN). See [ISO 15706-2].	0000-0001-2C52-0000-P-0000-0000-0

segmentation_upid_type	segmentation_upid_length (Bytes)	segmentation_upid() (Name)	Description	Example Textual Representation
0x07	12	TID	Tribune Media Systems Program identifier. 12 characters; 2 alpha characters followed by 10 numbers.	MV0004146400
0x08	8	TI	AiringID (Formerly Turner ID), used to indicate a specific airing of a Program that is unique within a network.	0x0A42235B81BC70FC (expressed as hexadecimal)
0x09	variable	ADI	CableLabs metadata identifier as defined in Section 10.3.3.2.	provider.com/MOVE1234567890123456
0x0A	12	EIDR	An EIDR (see [EIDR]) represented in Compact Binary encoding as defined in Section 2.1.1 in EIDR ID Format (see [EIDR ID FORMAT])	Content: 10.5240/0E4F-892E-442F-6BD4-15B0-1 Video Service: 10.5239/C370-DCA5 [SMPTE 2079]
0x0B	variable	ATSC Content Identifier	ATSC_content_identifier() structure as defined in [ATSC A/57B].	Not Defined
0x0C	variable	MPU()	Managed Private UPID structure as defined in Section 10.3.3.3.	User Defined
0x0D	variable	MID()	Multiple UPID types structure as defined in Section 10.3.3.4.	See referenced UPID types
0x0E	variable	ADS Information	Advertising information as described in Section 10.3.3.5.	type=LA&dur=60&pos=90&tier=1
0x0F	variable	URI	Universal Resource Identifier (see [RFC 3986]).	Urn:uuid:f81d4fae-7dec-11d0-a765-00a0c91e6bf6
0x10	16	UUID	Universally Unique Identifier (see [RFC 4122]). This segmentation_upid_type can be used instead of an URI if it is desired to transfer the UUID payload only.	0xCB0350A948774CA7BB638730B37A98CF (expressed as hexadecimal)
0x11	variable	SCR	Segment Content Reference as described in Section 10.3.3.6.	type=PI&tier=1
0x12-0xFF	variable	Reserved	Reserved for future standardization.	

segmentation_upid_length – Length in bytes of segmentation_upid() as indicated by Table 22. If there is no segmentation_upid() present, segmentation_upid_length *shall* be set to zero.

There is no entry in the XML schema for `segmentation_upid_length`. The value *shall* be derived when converting an XML representation of the SegmentationUpid to Bit Stream Format. In the case of UPID type MID(), this reflects the total length of nested UPID types structure (see Section 10.3.3.4.). If there are no SegmentationUpid elements in an XML representation, `segmentation_upid_length` *shall* be set to zero in the Bit Stream Format.

segmentation_upid() – Length and identification from Table 22. This structure’s contents and length are determined by the `segmentation_upid_type` and `segmentation_upid_length` fields. An example would be a type of 0x06 for ISAN and a length of 12 bytes. This field would then contain the ISAN identifier for the content to which this descriptor refers.

SegmentationUpid [Optional, xsd:SegmenationUpidType] Zero, one or more SegmentationUpid Elements *may* be specified. If multiple SegmentationUpid Elements are present in an XML representation, the MID() structure *shall* be generated per Section 10.3.3.4. See Section 10.3.3.12 for additional details on SegmentationUpidType.

segmentation_type_id – The 8-bit value *shall* contain one of the values in Table 23 to designate type of segmentation. All unused values are reserved. When the `segmentation_type_id` is 0x01 (Content Identification), the value of `segmentation_upid_type` *shall* be non-zero. If `segmentation_upid_length` is zero, then `segmentation_type_id` *shall* be set to 0x00 for Not Indicated.

Table 23 - segmentation_type_id

Segmentation Message	segmentation_type_id	segment_num	segments_expected	sub_segment_num	sub_segments_expected
	Hex (Decimal)				
Not Indicated	0x00 (00)	0	0	Not used	Not Used
Content Identification	0x01 (01)	0	0	Not used	Not Used
<i>Private</i>	0x02 (02)				
<i>Reserved</i>	0x03-0x0F				
Program Start	0x10 (16)	1	1	Not used	Not Used
Program End	0x11 (17)	1	1	Not used	Not Used
Program Early Termination	0x12 (18)	1	1	Not used	Not Used
Program Breakaway	0x13 (19)	1	1	Not used	Not Used
Program Resumption	0x14 (20)	1	1	Not used	Not Used
Program Runover Planned	0x15 (21)	1	1	Not used	Not Used
Program Runover Unplanned	0x16 (22)	1	1	Not used	Not Used
Program Overlap Start	0x17 (23)	1	1	Not used	Not Used
Program Blackout Override	0x18 (24)	0	0	Not used	Not Used
Program Join	0x19 (25)	1	1	Not used	Not used

SCTE 35 2023r1

Segmentation Message	segmentation_type_id	segment_num	segments_expected	sub_segment_num	sub_segments_expected
Program Immediate Resumption	0x1A (26)	0	0	Not used	Not used
<i>Reserved</i>	0x1B-0x1F				
Chapter Start	0x20 (32)	Non-zero	Non-zero	Not used	Not Used
Chapter End	0x21 (33)	Non-zero	Non-zero	Not used	Not Used
Break Start	0x22 (34)	0 or Non-zero	0 or Non-zero	Not used	Not used
Break End	0x23 (35)	0 or Non-zero	0 or Non-zero	Not used	Not used
Opening Credit Start <i>deprecated</i>	0x24 (36)	1	1	Not used	Not used
Opening Credit End <i>deprecated</i>	0x25 (37)	1	1	Not used	Not used
Closing Credit Start <i>deprecated</i>	0x26 (38)	1	1	Not used	Not used
Closing Credit End <i>deprecated</i>	0x27 (39)	1	1	Not used	Not used
<i>Reserved</i>	0x28-0x2F				
Provider Advertisement Start	0x30 (48)	0 or Non-zero	0 or Non-zero	0 or Non-zero	0 or Non-zero
Provider Advertisement End	0x31 (49)	0 or Non-zero	0 or Non-zero	Not used	Not Used
Distributor Advertisement Start	0x32 (50)	0 or Non-zero	0 or Non-zero	0 or Non-zero	0 or Non-zero
Distributor Advertisement End	0x33 (51)	0 or Non-zero	0 or Non-zero	Not used	Not Used
Provider Placement Opportunity Start	0x34 (52)	0 or Non-zero	0 or Non-zero	0 or Non-zero	0 or Non-zero
Provider Placement Opportunity End	0x35 (53)	0 or Non-zero	0 or Non-zero	Not used	Not Used
Distributor Placement Opportunity Start	0x36 (54)	0 or Non-zero	0 or Non-zero	0 or Non-zero	0 or Non-zero
Distributor Placement Opportunity End	0x37 (55)	0 or Non-zero	0 or Non-zero	Not used	Not Used

SCTE 35 2023r1

Segmentation Message	segmentation_type_id	segment_num	segments_expected	sub_segment_num	sub_segments_expected
Provider Overlay Placement Opportunity Start	0x38 (56)	0 or Non-zero	0 or Non-zero	0 or Non-zero	0 or Non-zero
Provider Overlay Placement Opportunity End	0x39 (57)	0 or Non-zero	0 or Non-zero	Not used	Not Used
Distributor Overlay Placement Opportunity Start	0x3A (58)	0 or Non-zero	0 or Non-zero	0 or Non-zero	0 or Non-zero
Distributor Overlay Placement Opportunity End	0x3B (59)	0 or Non-zero	0 or Non-zero	Not used	Not Used
Provider Promo Start	0x3C (60)	0 or Non-zero	0 or Non-zero	0 or Non-zero	0 or Non-zero
Provider Promo End	0x3D (61)	0 or Non-zero	0 or Non-zero	Not used	Not used
Distributor Promo Start	0x3E (62)	0 or Non-zero	0 or Non-zero	0 or Non-zero	0 or Non-zero
Distributor Promo End	0x3F (63)	0 or Non-zero	0 or Non-zero	Not used	Not used
Unscheduled Event Start	0x40 (64)	0	0	Not used	Not Used
Unscheduled Event End	0x41 (65)	0	0	Not used	Not Used
Alternate Content Opportunity Start	0x42 (66)	0 or Non-zero	0 or Non-zero	Not used	Not Used
Alternate Content Opportunity End	0x43 (67)	0 or Non-zero	0 or Non-zero	Not used	Not Used
Provider Ad Block Start	0x44 (68)	0 or Non-zero	0 or Non-zero	0 or Non-zero	0 or Non-zero
Provider Ad Block End	0x45 (69)	0 or Non-zero	0 or Non-zero	Not used	Not Used
Distributor Ad Block Start	0x46 (70)	0 or Non-zero	0 or Non-zero	0 or Non-zero	0 or Non-zero
Distributor Ad Block End	0x47 (71)	0 or Non-zero	0 or Non-zero	Not used	Not Used
<i>Reserved</i>	0x48-0x4F				
Network Start	0x50 (80)	0	0	Not used	Not Used
Network End	0x51 (81)	0	0	Not used	Not Used

Segmentation Message	segmentation_type_id	segment_num	segments_expected	sub_segment_num	sub_segments_expected
<i>Reserved</i>	0x52-0FF				

Notes:

1. Only one Program Overlap Start is allowed to be active at a time. A Program End *shall* occur before a subsequent Program Overlap Start can occur.
2. See [SCTE 223] for further usage of `segmentation_type_id`.
3. The opening credit and closing credit start/end types are *deprecated*. New implementations *should* use the Segment Content Reference for this purpose.

segment_num – This field provides support for numbering segments within a given collection of Segments (such as Chapters or Advertisements). This value, when utilized, is expected to reset to one at the beginning of a collection of Segments. This field is expected to increment for each new Segment (such as a Chapter). The value of this field *shall* be as indicated in Table 23.

@segmentNum [Optional, xsd:unsignedByte]

segments_expected – This field provides a count of the expected number of individual Segments (such as Chapters) within a collection of Segments. The value of this field *shall* be as indicated in Table 23.

@segmentsExpected [Optional, xsd:unsignedByte]

sub_segment_num – `sub_segment_num` is optional for the applicable `segment_type_id` values in Table 23. If specified, this field provides identification for a specific sub-Segment within a collection of sub-Segments. This value, when utilized, is expected to be set to one for the first sub-Segment within a collection of sub-Segments. This field is expected to increment by one for each new sub-Segment within a given collection. If present, `descriptor_length` *shall* include `sub_segment_num` in the byte count and serve as an indication to an implementation that `sub_segment_num` is present in the descriptor.

The value of this field *shall* be as indicated in Table 23. Any other usage of `sub_segment_num` beyond that defined in Table 23 is out of scope of this standard.

@subSegmentNum [Optional, xsd:unsignedByte]

sub_segments_expected – `sub_segments_expected` *shall* be present if `sub_segment_num` is present. If specified, this field provides a count of the expected number of individual sub-Segments within the collection of sub-Segments. If present, `descriptor_length` *shall* include `sub_segments_expected` in the byte count and serve as an indication to an implementation that `sub_segments_expected` is present in the descriptor.

The value of this field *shall* be as indicated in Table 23. Any other usage of `sub_segments_expected` beyond that defined in Table 23 is out of scope of this standard.

@subSegmentsExpected [Optional, xsd:unsignedByte]

10.3.3.2. CableLabs metadata identifier

When the value of `segmentation_upid_type` is 0x09 (ADI), it *shall* have the abbreviated syntax of `<element> : <identifier>`. The variable `<element>` *shall* take only the values “PREVIEW”, “MPEG2HD”, “MPEG2SD”, “AVCHD”, “AVCSD”, “HEVCSD”, “HEVCHD”, “SIGNAL”, “PO” (PlacementOpportunity), “BLACKOUT”, “BREAK”, and “OTHER”.

For CableLabs Content metadata 1.1 the variable `<identifier>` *shall* take the form `<providerID>/<assetID>`, the variables `<providerID>` and `<assetID>` *shall* be as specified in [CLADI1-1] Sections 5.3.1 for Movie or 5.5.1 for Preview represented as 7-bit printable ASCII characters (values ranging from 0x20 (space) to 0x7E (tilde)).

SCTE 236⁶ provides compatibility with this identifier model as described in [SCTE 236] Section 7.11.1.

Any specifics on the systems that will ingest and process this information are out of scope of this standard.

10.3.3.3. MPU() definition and semantics

Table 24 – MPU()

Syntax	Bits	Mnemonic
MPU() { format_identifier private_data }	32 N*8	uimbsf uimbsf

format_identifier – A 32-bit unique identifier as defined in ISO/IEC 13818-1 and registered with the SMPTE Registration Authority (See [SMPTE RA]).

private_data – A variable length, byte-aligned, set of data as defined by the registered owner of the `format_identifier` field value. The length is defined by the `segmentation_upid_length`, which includes the `format_identifier` field length.

10.3.3.4. MID() definition and semantics

Table 25 – MID()

Syntax	Bits	Mnemonic
MID() { for (i=0; i<N; i++) { segmentation_upid_type length segmentation_upid } }	8 8 N*8	uimbsf uimbsf uimbsf

segmentation_upid_type – As defined above.

⁶ Formerly CableLabs Content 3.0

Length – segmentation_upid_length for the following segmentation_upid.

Segmentation_upid – segmentation_upid according to segmentation_upid_type as defined in Table 22.

Note: The number of segmentation_upid's present ("N") is not explicitly signaled. It is discovered by repeatedly parsing the fields above until segmentation_upid_length is exhausted.

There is no structure in the XML schema for MID(). When converting an XML document to Bit Stream Format, the presence of two or more SegmentationUpid Elements *shall* result in a MID() structure being inserted into the bit stream.

10.3.3.5. ADS format and definition

When the value of the segmentation_upid_type is 0x0E (ADS), it *shall* provide one or more key-value pairs using the following convention:

- Key-value Separator “=”
- Key-value Delimiter “&”
- Serial Separator “;”

This is in order to convey additional information about the Segment to distribution systems. Keys *may* consist of values from the following list:

- type – The type of advertising referenced in the Segment. They *may* include:
 - LA – Local Operator Availability
 - NA – National Addressable advertising
 - NR – National Replacement advertising
 - CV – Creative Versioning advertising
 - C3 – Nielsen VOD ratings credit for 3 days
 - C7 – Nielsen VOD ratings credit for 7 days
- pos – Start point (in milliseconds) of referenced advertising relative to the start of the Segment.
- dur – Duration (in milliseconds) of referenced advertising
- tier – Replacement authorization designation

10.3.3.6. SCR description and format

When the value of the segmentation_upid_type is 0x11 (SCR), it *shall* provide one or more key-value pairs using the following convention:

- Key-value Separator “=”
- Key-value Delimiter “&”
- Serial Separator “;”

The SCR conveys additional information about a Segment in order to indicate context-based features, in-band, for authorized distributors and reuse of content. An example use case would be to further describe a Chapter Segment as a Program Recap that could be skipped or replaced during viewing. Keys *may* consist of values from the following list:

- type – The type of content referenced in the Segment. They *may* include:
 - o PI – Program Intermission
 - o PR – Program Recap
 - o DP – Decision Point for branching narratives
 - o CC – Closing Credits
 - o OC – Opening Credits
 - o OOC – Overlaid Opening Credits
- tier – Authorization designation

10.3.3.7. Segmenting Content – Additional semantics

One use of a segmentation descriptor is to signal Content, Advertising and Alternate Content Segments. Content Segments **shall** adhere to the hierarchy of Network (highest level), Program, and Chapter.

Advertising segments **shall** adhere to the hierarchy of Break (highest level), Placement Opportunity, and Ad Block. Advertisement and Promo (refer to Table 23) share the lowest logical level and **shall not** overlap. Advertising segments *may* be defined within a Program or Chapter or outside of a Program or Chapter.

Alternate Content segments may be defined within Content or Advertisement segments.

All Segmentation Types within the hierarchy are not required to be present.

See Section 6.7 for usage examples.

For the purposes of defining the semantics stated in this document section, the following definition applies:

segmentation_type_id – **Shall** be one of the `segmentation_type_id` values from Table 23, listed below. Occurrences of the `segmentation_descriptor()` that support Segments typically occur in pairs. The valid pairings are:

- Program Start/End – Program End can be overridden by Program Early Termination
- Program Overlap Start/Program End
- Program Join/ Program End – Program End can be overridden by Program Early Termination
- Program Breakaway/Resumption
- Chapter Start/End
- Break Start/End
- Opening Credit Start/End
- Closing Credit Start/End
- Provider Advertisement Start/End
- Distributor Advertisement Start/End
- Provider Placement Opportunity Start/End
- Distributor Placement Opportunity Start/End
- Provider Overlay Placement Opportunity Start/End
- Distributor Overlay Placement Opportunity Start/End
- Provider Promo Start/End
- Distributor Promo Start/End
- Provider Ad Block Start/End

- Distributor Ad Block Start/End
- Unscheduled Event Start/End
- Alternate Content Opportunity Start/End
- Network Start/End

The following segmentation_type_ids (from Table 23) also support Segments but are not paired:

- Program Runover Planned
- Program Runover Unplanned
- Program Immediate Resumption

The following segmentation_type_ids (from Table 23) are outside of the scope of this document section. They are not considered to support Segments (Segmenting Content):

- Not Indicated
- Content Identification

Descriptors *should* normally be paired, once for a given Segment start and then for Segment end. Each Segment end usage *may* be followed by another Segment start of the same logical level Segment. Refer to Section 10.3.3.8 (Programs), Section 10.3.3.9 (Chapters), Section 10.3.3.8 (Breaks), Section 10.3.3.13 (Placement Opportunities) and Section 10.3.3.12 (Alternate Content Opportunities) for additional semantics. When a Segment’s duration is provided, and that duration expires without a Segment end being signaled, then the value of segmentation_event_id *may* be reused if appropriate. Such inferred Segment end cases are not to be encouraged and *should not* be used.

In order to associate different types of segmentation constructs (such as associating Program level constructs with Chapter level constructs) the same segmentation_upid() *may* be used in the associated constructs. This however is not required.

If multiple commands are utilized to send multiple segmentation_descriptor()s referencing the same PTS, the order of the commands in the Cue Stream *should* ensure compliance with this standard. If multiple segmentation_descriptor()s are utilized in a given command the order of the segmentation_descriptor()s in the descriptor loop *should* ensure compliance with this standard. For example,

1. Multiple Commands – A command with a segmentation_descriptor() with segmentation_type_id of “Provider Placement Opportunity Start” should precede a command with a segmentation_descriptor() with segmentation_type_id of “Provider Advertisement Start” in the Cue Stream.
2. Multiple segmentation_descriptor()s in a Command – A segmentation_descriptor() with segmentation_type_id of “Provider Placement Opportunity Start” in the descriptor loop should precede a segmentation_descriptor() with segmentation_type_id of “Provider Advertisement Start” in the descriptor loop.

The semantics of the fields within the segmentation_descriptor() for segmenting content are as follows (subject to additional constraints in other sections):

segmentation_event_id – When a Segment start is signaled, the segmentation_event_id value becomes active. While active, this value *shall not* be used to identify other segmentation events. When a Segment end is signaled, the segmentation_event_id value *shall* match the Segment start segmentation_event_id value and this value then becomes inactive and hence able to be used again for a new segmentation_descriptor() occurrence including non-Segment usage such as Content Identification.

program_segmentation_flag – *Shall* be set to ‘1’.

segmentation_duration_flag – If set to ‘1’, a valid **segmentation_duration** *shall* be included in the descriptor. If **segmentation_type_id** is set to 0x10 (Program Start) then this flag *may* be set to ‘0’.

segment_num, segments_expected, sub_segment_num and **sub_segments_expected** – *Shall* be set based on the columns in Table 23. **sub_segment_num** and **sub_segments_expected** are optional. For usage **sub_segment_num** and **sub_segments_expected** review the applicable text in the sections listed.

The following sections provide additional constraints on usage of values in the **segmentation_descriptor**:

- Section 10.3.3.9 – Chapters
- Section 10.3.3.10 – Breaks
- Section 10.3.3.13 – PlacementOpportunity
- Section 10.3.3.14 - Advertisement, Promo and Ad Block
- Section 10.3.3.15 - Alternate Content

10.3.3.8. Programs - Additional semantics

When signaled, a Program *shall* begin with a **segmentation_descriptor()** containing a **segmentation_type_id** value of 0x10 (Program Start). The Program *shall* utilize a single and unique value for **segmentation_event_id** in all descriptors that pertain to this Program. The usage of a **segmentation_upid()** is optional but, if used, its value *shall* be uniquely assigned to this Program and not shared by Programs that are embedded within this Program. A Program *shall* end with a **segmentation_descriptor()** containing a **segmentation_type_id** value of 0x11 (Program End) or 0x12 (Program Early Termination).

The following segmentation messages *shall* only occur between the Program Start and Program End or Program Early Termination: Program Breakaway (**segmentation_type_id** value of 0x13); Program Resumption (**segmentation_type_id** value of 0x14); Program Runover Planned (**segmentation_type_id** value of 0x15); Program Runover Unplanned (**segmentation_type_id** value of 0x16); or Program Immediate Resumption (**segmentation_type_id** of 0x1A). A Program Resumption *shall* be preceded by a Program Breakaway. A Program *may* be ended while in a Program Breakaway state.

Following a Program Breakaway, another Program Start to Program End sequence *may* occur, with new values of **segmentation_event_id** and **segmentation_upid()**. An entire embedded Program or Segments of an embedded Program *shall* be situated only between a Program Breakaway and a Program Resumption. Multiple instances of embedded Programs *may* occur. Note: Program Runover messages are asynchronous notifications and *may* occur at any time between the start and end of the Program including within another embedded active Program.

A Program Blackout Override (**segmentation_type_id** value of 0x18) *may* be sent between a Program Start or Program Start Join and Program End or Program Early Termination. When a Program Blackout Override is received, the Delivery Restrictions from the Program Blackout Override message *may* be applied to the referenced Program (see Section 10.3.3.11 “Delivery Restrictions – Additional Semantics”).

A Program Immediate Resumption *may* be sent during a blackout or during advertising segments. For blackouts, system behavior will be defined via external data (ex. SCTE 224) or system configuration. For advertising segments, the advertising insertion system, client side or server side, *should* terminate any advertising insertions in progress and return to the original transport stream. If active advertising insertions are terminated, all the advertising segmentation messages *shall* be considered ended. The

command timing for Program Immediate Resumption *shall* comply with the timing defined in Section 10.3.3.

If provided, the `segmentation_duration` *shall* be considered from the `splice_time()` of the `time_signal` command, if time is present, otherwise from the time the message is received. The duration clock continues to increment during Program Breakaways. `segmentation_duration` can be extended using a Runover Planned or Runover Unplanned message. The value supplied in the new message is an update to the overall duration of the Program and represents the elapsed time from the effective moment of the new message to the end of the Segment. It is not an addition of elapsed time. If `segmentation_duration` is specified, when the duration is exceeded the Program *shall* be considered terminated.

If at Program Start a duration is not provided, a duration *may* be provided at a later time using a Program Runover Planned or Program Runover Unplanned message.

If a duration is in effect, either set at Program Start or later introduced, `segmentation_duration` *may* be set to zero by sending a Program Runover Planned or Program Runover Unplanned message with `segmentation_duration_flag` set to '0'.

Programs can be identified by including one or more segmentation UPIDs. If a given Program is aired multiple times a TI (0x08) *should* be supplied to differentiate each airing.

A Content Identification (value of `segmentation_type_id` 0x01) message with a value of `segmentation_upid()` matching the currently active Program *may* be sent on a periodic basis to make an implementation more robust. If sent, it *shall* match the values of `segmentation_event_id` and `segmentation_upid()` used in the Program related messages.

This does not restrict Content Identification messages being sent that do not match the `segmentation_event_id` and `segmentation_upid()` used in the Program related messages. Other Content Identification messages can be inserted for other purposes.

10.3.3.9. Chapters - Additional semantics

A Chapter Segment *shall* be introduced by a Chapter Start and ended by a Chapter End. For Chapter End, the value of `segmentation_event_id` *shall* match the value of `segmentation_event_id` for Chapter Start. If present, the `segmentation_upid()` *shall* be the same in both occurrences of a `segmentation_descriptor()` pair.

Chapter Segments *may* be associated with Program Segments using the same `segmentation_upid()` on both Chapter and Program messages.

Chapters *may* overlap. Chapters can be numbered using `segment_num`. The value of `segments_expected` on the Chapter Start *shall* indicate the expected number of Chapters. Use of non-zero values for `segmentation_duration` on Chapter Start is optional.

If a Chapter segment is contained within a Program, if there is a Program Breakaway, the Chapter is also considered broken away from. When there is a Program Resumption, the Chapter is resumed. If Program Breakaway is anticipated and `segmentation_duration` is utilized, the value for `segmentation_duration` should account for any anticipated breakaway timing.

10.3.3.10.Break – Additional semantics

Break numbering via Break Starts *shall* be supported per the following. The numbering of Breaks via Break Start messages are dependent on what is sent by a Provider in the Cue Stream:

- a) Program Segmentation descriptors are present in the Cue Stream and Break numbering within a Program is not supported.
- b) Program Segmentation descriptors are present in the Cue Stream and Break numbering within a Program is supported.
- c) Program Segmentation descriptors are not present in the Cue Stream and Break numbering within a Program is not supported.
- d) Program Segmentation descriptors are not present in the Cue Stream and Break numbering within a Program is supported.

If Program Segmentation descriptors (see Section 10.3.3.8) are present in the Cue Stream and Break numbering within a Program is not supported, Break Starts within the Program *shall* comply with the following:

- segments_expected in all Break Starts *shall* be set to 0 (zero).
- segment_num in all Break Starts *shall* be set to 0 (zero).

If Program Segmentation descriptors (see Section 10.3.3.8) are present in the Cue Stream and Break numbering within a Program is supported, Break Starts *shall* comply with the following:

- segments_expected in all Break Starts in a collection of Breaks within a Program *shall* be set to the expected number of Breaks within the Program.
- segment_num on the first Break Start *shall* be set to 1 (one) for the first Break and incremented by 1 for each subsequent Break within the Program.

10.3.3.11.Delivery Restrictions – Additional semantics

Delivery restrictions on the following segmentation types *may* be applied in the absence of out of band data as described later in this section.

- Program Start
- Program Resumption
- Program Runover Planned
- Program Runover Unplanned
- Program Overlap Start
- Program Blackout Override
- Program Join
- Chapter Start
- Break Start
- Provider Advertisement Start
- Distributor Advertisement Start
- Provider Placement Opportunity Start
- Distributor Placement Opportunity Start
- Unscheduled Event Start
- Alternate Content Opportunity Start
- Network Start

Delivery restrictions in end messages *shall* be ignored.

For Programs, a Program Blackout Override *shall* be used to provide new values for the delivery restrictions for the associated Program Start, Program Start Join or Program Overlap Start message. See Section 10.3.3.8 for additional information.

For Programs, a Program Resumption *may* include new values for the delivery restrictions for the associated Program Start, Program Join, or Program Overlap Start message.

The delivery restrictions from the most recent message *shall* be applied.

In addition to delivery restrictions in the SCTE 35 message, out of band data *may* be supplied (see [SCTE 224]). If there is matching out of band data, the matching out of band data that applies to the given Program, Advertisement, Promo or Unscheduled Event *should* supersede the delivery flags and device restrictions from the SCTE 35 message.

10.3.3.12. Content Identifiers – Additional semantics

The following constraints *shall* be applied when including content identifiers in Segmentation Descriptors.

Programs *should* be identified using both video service and tv/movie EIDRs [EIDRA] (segmentation_upid_type=0x0A).

As an alternative to EIDR, an AiringID that is globally unique to a given video service *may* be supplied (segmentation_upid_type=0x08). If known, the video service and tv/movie EIDRs [EIDR] *should* be supplied via some out of band mechanism. Alternate identifiers in an [SCTE 224] message is a mechanism that *may* be leveraged.

Advertisements *should* be identified using Distributor Advertisement Start or Provider Advertisement Start. The identifier *should* be an Ad-ID [Ad-ID] (segmentation_upid_type=0x03).

Promos *should* be identified using Distributor Promo Start or Provider Promo Start. If a content provider does not support dedicated identification of Promos, these Segments can be signaled as Advertisements. The identifier *should* be an Ad-ID [Ad-ID] (segmentation_upid_type=0x03).

This does not restrict to use any other appropriate segmentation_upid_type out of Table 22 for Programs and Advertisements.

10.3.3.13. Placement Opportunities – Additional semantics

The additional semantics and constraints in this section shall apply to Placement Opportunity paired messages listed in Table 23 namely, Provider Placement Opportunity, Distributor Placement Opportunity, Provider Overlay Placement Opportunity and Distributor Overlay Placement Opportunity.

A Placement Opportunity *shall* be introduced by a corresponding Start message (for example, Provider Placement Opportunity Start) and closed by an associated End message (for example, Provider Placement Opportunity End). In the scenario where one Placement Opportunity is followed by another, the Placement Opportunity End segmentation message from one and Placement Opportunity Start segmentation in the next *may* reference the same PTS. In the scenario where a time shifted insertion opportunity is being indicated (ex. support VOD ad insertion vs VOD ad replacement), the Placement Opportunity Start and Placement Opportunity End segmentation message *may* reference the same Splice Point.

The Placement Opportunity Start segmentation types and associated Placement Opportunity End segmentation types *shall* have the same segmentation_event_id. See Section 10.3.3.7 for additional constraints on segmentation_event_id.

A Placement Opportunity *may* contain one or more nested Placement Opportunities. The Placement Opportunity Start and associated Placement Opportunity Ends for a contained Placement Opportunity *shall* be within the Placement Opportunity Start and first Placement Opportunity End of the containing Placement Opportunity.

10.3.3.13.1. Placement Opportunity Identifiers

Each Placement Opportunity Start and End *shall* be uniquely identifiable by utilizing:

- Any appropriate segmentation_upid_type out of Table 22
- segmentation_upid set to a unique identifier

If the Placement Opportunity Start and End will be utilized to support downstream processing (e.g. Ad Decision System, SCTE 224/250 Signal Decision System, other Delivery Platforms, etc.), the segmentation message *may* also include an additional unique identity for the opportunity. In certain cases the Placement Opportunity Identifier may be utilized with other delivery platforms. The identifier schema should account for any constraints imposed by any downstream systems. In this case, the following *may* be utilized:

- segmentation_upid_type set to 0x09
- segmentation_upid set to “PO:<unique PO identifier>”

If Placement Opportunity identifiers are present, associated Placement Opportunity Start and End *shall* carry the same Placement Opportunity identifiers. A given Placement Opportunity identifier *shall* appear in one Placement Opportunity Start and one Placement Opportunity End.

A base-64 encoded GUID is one mechanism to generate a unique identifier. See [RFC 4648] for additional information on base-64 encoding.

See Section 10.3.3.2 for additional information on CableLabs metadata identifiers.

10.3.3.13.2. Placement Opportunity Break Numbering

Break numbering via Placement Opportunity Starts *shall* be supported per the following. The numbering of Breaks via Placement Opportunity Start messages are dependent on what is sent by a Provider in the Cue Stream sent to a Distributor:

- a) Program Segmentation descriptors are present in the Cue Stream and Break numbering within a Program is not supported.
- b) Program Segmentation descriptors are present in the Cue Stream and Break numbering within a Program is supported.
- c) Program Segmentation descriptors are not present in the Cue Stream and Break numbering within a Program is not supported.
- d) Program Segmentation descriptors are not present in the Cue Stream and Break numbering within a Program is supported.

A Break *may* have one or more Placement Opportunities. All Placement Opportunity Starts in a given Break *shall* have the same values for `segment_num` and `segments_expected`.

If Program Segmentation descriptors (see Section 10.3.3.8) are present in the Cue Stream and Break numbering within a Program is not supported, Placement Opportunity Starts within the Program *shall* comply with the following:

- `segments_expected` in all Placement Opportunity Starts *shall* be set to 0 (zero).
- `segment_num` in all Placement Opportunity Starts *shall* be set to 0 (zero).

If Program Segmentation descriptors (see Section 10.3.3.8) are present in the Cue Stream and Break numbering within a Program is supported, Placement Opportunity Starts *shall* comply with the following:

- `segments_expected` in all Placement Opportunity Starts within a Program *shall* be set to the expected number of Breaks within the Program.
- `segment_num` on all Placement Opportunity Starts associated with the first Break *shall* be set to 1 (one) and incremented by 1 for all Placement Opportunity Starts associated with each subsequent Break within the Program.

For example, if a Program has 3 Breaks, all Placement Opportunities will have `segments_expected` set to 3. In the first Break, all Placement Opportunity Starts will have `segment_num` set to 1. In the second Break, all Placement Opportunity Starts will have a `segment_num` set to 2. In the last Break, all Placement Opportunity Starts will have a `segment_num` set to 3.

If the number of Breaks changes, increase or decrease within the Program, `segments_expected` on the next Placement Opportunity Start *shall* be updated with the new `segments_expected`. If the number of Breaks is reduced after the last set of Placement Opportunity Starts are sent for a Break, the distributor implementation *should* recognize that no additional Breaks exist for a Program when the Program End message is received.

If Program Segmentation descriptors are not present in the Cue Stream and Break numbering within a Program is not supported, all Placement Opportunity Starts *shall* comply with the following:

- `segments_expected` *shall* be set to 0 (zero)
- `segment_num` *shall* be set to 0 (zero).

If Program segmentation descriptors are not present in the Cue Stream and Breaks are numbered by the Content Provider, Placement Opportunity Starts *shall* comply with the following:

- `segments_expected` in all Placement Opportunity Starts *shall* be set to the expected number of Breaks defined by the Content Provider.
- `segment_num` on all Placement Opportunity Starts associated with the first Break *shall* be set to 1 (one) and incremented by 1 for all Placement Opportunity Starts associated with each subsequent Break as defined by the Content Provider.

For example, if a Content Provider chooses to have 3 Breaks in the next 30 minutes of Content, all Placement Opportunities will have `segments_expected` set to 3. In the first Break, all Placement Opportunity Starts will have `segment_num` set to 1. In the second Break, all Placement Opportunity Starts will have a `segment_num` set to 2. In the last Break, all Placement Opportunity Starts will have a `segment_num` set to 3.

If the number of Breaks changes, increase or decrease segments_expected on subsequent Placement Opportunity Starts **shall** be updated with the new segments_expected. If the number of Breaks is reduced after the last Placement Opportunity Start is sent for a Break, the distributor implementation *should* recognize that no additional Breaks will be signaled for the interval selected by the Content Provider when the next Placement Opportunity Start with segment_num equal to 1 is received. Since there are no Program related segmentation descriptors, the implementation *should* recognize when segment_num is reset to one to indicate when a new interval is initiated by the Content Provider.

A Placement Opportunity **shall** have one or more Placement Opportunity Ends.

10.3.3.13.3. Numbering of Placement Opportunities

The numbering of Placement Opportunities within a Break is dependent on whether:

- a) Placement Opportunity numbering within a Break is not supported
- b) Placement Opportunity numbering within a Break is supported

These constraints **shall** apply to all Placement Opportunities in a Break independent of the type. For example, if the stream contains a Provider Placement Opportunity Start, a Distributor Placement Opportunity Start and a Provider Placement Opportunity Start the numbering would be as follows:

Table 26 – Placement Opportunity Start Numbering Example

Message	sub segment num	sub_segments_expected
Provider Placement Opportunity Start	1	3
Distributor Placement Opportunity Start	2	3
Provider Placement Opportunity Start	3	3

If Placement Opportunities within a Break are not numbered the Placement Opportunity Start **shall** comply with one of the following:

- sub_segment_num and sub_segments_expected *may* be omitted

OR

- sub_segments_expected **shall** be set to 0 (zero)
- sub_segment_num on all Placement Opportunity Starts **shall** be set to 0 (zero)
- both sub_segment_num and sub_segments **shall** be present in the segmentation descriptor and included in the overall byte count for the segmentation descriptor

If Placement Opportunities within a Break are numbered and contains only one opportunity the Placement Opportunity Start *should* comply with the following:

- sub_segments_expected **shall** be set to 1 (one)
- sub_segment_num on the first Placement Opportunity Start **shall** be set to 1 (one)

If the number of Placement Opportunities within a Break increases from 1 (one) after the first Placement Opportunity Start for the Break is sent, `sub_segments_expected` on the next Placement Opportunity Start **shall** be updated with the new `sub_segments_expected`.

If Placement Opportunities within a Break are numbered and there are multiple Placement Opportunity Starts within a Break, the Placement Opportunity Starts **shall** comply with the following:

- `sub_segments_expected` **shall** be set to the expected number of Placement Opportunity Start messages expected within the Break.
- `sub_segment_num` on the first Placement Opportunity Start **shall** be set to 1 (one) and incremented by one on each subsequent Placement Opportunity Start.

If the number of Placement Opportunities change, increase or decrease within the Break, `sub_segments_expected` on the next Placement Opportunity Start **shall** be updated with the new `sub_segments_expected`. If the number of Placement Opportunities is reduced after the last Placement Opportunity Start is sent for a Break, the distributor implementation *should* recognize that no additional Placement Opportunities will be signaled when the next Placement Opportunity Start with `sub_segment_num` equal to 1 (one) is received.

10.3.3.13.4. Multiple Placement Opportunity End Messages

Additional Placement Opportunity End segmentation types that have the same `segmentation_event_id` as the Placement Opportunity Start *may* be present. To inform downstream systems of the number of Placement Opportunity End segmentation types to be expected in the PID stream associated with a given Placement Opportunity Start, the segmentation descriptor **shall** comply with the following:

- `segmentation_duration` on the Placement Opportunity Start **shall** be the duration defined by the last Placement Opportunity End.
- `segmentation_event_id` **shall** have the same value on all Placement Opportunity End segmentation types as the associated Placement Opportunity Start.
- `segments_expected` on all Placement Opportunity End segmentation types **shall** be set to the number of Placement Opportunity End segmentation types to be sent.
- `segment_num` on the first Placement Opportunity End **shall** be set to 1 (one) and incremented by one on each subsequent Placement Opportunity End.
- `segmentation_upid` on the Placement Opportunity Start or Placement Opportunity End *may* include one Placement Opportunity identifier or, if more than one Placement Opportunity identifier, Placement Opportunity identifiers in a MID() structure.

If the number of Placement Opportunity Ends change, increase or decrease, within the Placement Opportunity, `segments_expected` on the next Placement Opportunity End **shall** be updated with the new `segments_expected`. If the number of Placement Opportunity Ends is reduced after the last Placement Opportunity End is sent for a Placement Opportunity, the distributor implementation *should* recognize that no additional Placement Opportunity Ends will be signaled when the next Placement Opportunity message with a new `segmentation_event_id` is received.

The `segmentation_duration` on the Placement Opportunity Start **shall** be the duration of the underlying content for the Break. If multiple Placement Opportunity End segmentation types are associated with a Placement Opportunity Start, the `segmentation_duration` in the Placement Opportunity Start *should* be the duration defined by the last Placement Opportunity End sharing the same `segmentation_event_id`. If a Placement Opportunity End with a `segment_num` equal to expected Placement Opportunity Ends is received prior to reaching the duration in the Placement Opportunity Start, the Placement Opportunity **shall** be considered closed.

In those cases where a Provider chooses to provide supplemental information to a Distributor, the information *may* be passed in a segmentation_upid using a segmentation_upid_type of ADS Information (0x0E). An out of band mechanism *may* also be leveraged to provide supplemental information about a Placement Opportunity (See [SCTE 224]).

10.3.3.14. Advertisements, Promos and Ad Blocks – Additional semantics

The additional semantics and constraints in this section shall apply to Advertisement, Promo and Ad Block paired messages listed in Table 23 namely, Provider Advertisement, Distributor Advertisement, Provider Ad Block, Distributor Ad Block, Provider Promo and Distributor Promo.

An Advertisement, Promo or Ad Block *shall* be introduced by a corresponding Start message (for example, Provider Advertisement Start) and closed by an associated End message (for example, Provider Advertisement End). In the scenario where one Advertisement, Promo or Ad Block is followed by another, the End segmentation message from one and the Start segmentation in the next *may* reference the same Splice Point.

The Start segmentation types and associated End segmentation types *shall* have the same segmentation_event_id. See Section 10.3.3.7 for additional constraints on segmentation_event_id.

An Advertisement *shall not* contain nested Advertisement segmentation messages. A Promo *shall not* contain nested Promo segmentation messages. An Ad Block *shall not* contain nested Ad Block segmentation messages.

10.3.3.14.1. Advertiser, Promo and Ad Block Identifiers

Each Start and End *shall* be uniquely identifiable by utilizing:

- Any appropriate segmentation_upid_type out of Table 22
- segmentation_upid set to a unique identifier

If the Advertisement, Promo or Ad Block Start and End will be utilized to support ad replacement, the segmentation message *may* also include an additional unique identity for the opportunity. In this case, the following *shall* be utilized:

- segmentation_upid_type set to 0x09
- segmentation_upid set to “PO:<Base64 encoded GUID>”

If opportunity identifiers are present, associated Start and End *shall* carry the same identifiers. A given opportunity identifier *shall* appear in one Start and one End.

See [RFC 4648] for additional information on base-64 encoding. See Section 10.3.3.2 for additional information.

10.3.3.14.2. Advertisement, Promo and Ad Block Break Numbering

Break numbering via Advertisement, Promo or Ad Block Starts *shall* be supported per the following. The numbering of Breaks via Start messages are dependent on what is sent by a Provider in the Cue Stream sent to a Distributor:

- e) Program Segmentation descriptors are present in the Cue Stream and Break numbering within a Program is not supported.
- f) Program Segmentation descriptors are present in the Cue Stream and Break numbering within a Program is supported.
- g) Program Segmentation descriptors are not present in the Cue Stream and Break numbering within a Program is not supported.
- h) Program Segmentation descriptors are not present in the Cue Stream and Break numbering within a Program is supported.

A Break **may** have one or more Advertisements, Promos or Ad Blocks. All Starts in a given Break **shall** have the same values for `segment_num` and `segments_expected`.

If Program Segmentation descriptors (see Section 10.3.3.8) are present in the Cue Stream and Break numbering within a Program is not supported, Starts within the Program **shall** comply with the following:

- `segments_expected` in all Starts **shall** be set to 0 (zero).
- `segment_num` in all Starts **shall** be set to 0 (zero).

If Program Segmentation descriptors (see Section 10.3.3.8) are present in the Cue Stream and Break numbering within a Program is supported, Starts **shall** comply with the following:

- `segments_expected` in all Starts within a Program **shall** be set to the expected number of Breaks within the Program.
- `segment_num` on all Starts associated with the first Break **shall** be set to 1 (one) and incremented by 1 for all Starts associated with each subsequent Break within the Program.
- The numbering of Breaks **shall** comply with these constraints even if there are no messages present for a given Break.

For example, if a Program has 3 Breaks, all Advertisement, Promo or Ad Block segmentation messages will have `segments_expected` set to 3. In the first Break, all Starts will have `segment_num` set to 1. In the second Break, all Starts will have a `segment_num` set to 2. In the last Break, all Starts will have a `segment_num` set to 3. Further, if there are no messages for the first Break, the Starts in the second break will have a `segment_num` set to 2.

If the number of Breaks changes, increase or decrease within the Program, `segments_expected` on the next Start **shall** be updated with the new `segments_expected`. If the number of Breaks is reduced after the last set of Starts are sent for a Break, the distributor implementation **should** recognize that no additional Breaks exist for a Program when the Program End message is received.

If Program Segmentation descriptors are not present in the Cue Stream and Break numbering within a Program is not supported, all Advertisement, Promo or Ad Block Starts **shall** comply with the following:

- `segments_expected` **shall** be set to 0 (zero)
- `segment_num` **shall** be set to 0 (zero).

If Program segmentation descriptors are not present in the Cue Stream and Breaks are numbered by the Content Provider, Advertisement, Promo or Ad Block Starts **shall** comply with the following:

- `segments_expected` in all Starts **shall** be set to the expected number of Breaks defined by the Content Provider.
- `segment_num` on all Starts associated with the first Break **shall** be set to 1 (one) and incremented by 1 for all Starts associated with each subsequent Break as defined by the Content Provider.

For example, if a Content Provider chooses to have 3 Breaks in the next 30 minutes of Content, all Starts will have segments_expected set to 3. In the first Break, all Starts will have segment_num set to 1. In the second Break, all Starts will have a segment_num set to 2. In the last Break, all Starts will have a segment_num set to 3. Further, if there are no messages for the first Break, the Starts in the second break will have a segment_num set to 2.

If the number of Breaks changes, increase or decrease segments_expected on subsequent Starts *shall* be updated with the new segments_expected. If the number of Breaks is reduced after the last Start is sent for a Break, the distributor implementation *should* recognize that no additional Breaks will be signaled for the interval selected by the Content Provider when the next Start with segment_num equal to 1 is received. Since there are no Program related segmentation descriptors, the implementation *should* recognize when segment_num is reset to one to indicate when a new interval is initiated by the Content Provider.

10.3.3.14.3. Numbering of Ad Blocks

The numbering of Ad Blocks, Provider or Distributor, within a Break is dependent on whether:

- a) Advertisement numbering within a Break is not supported
- b) Advertisement numbering within a Break is supported

These constraints *shall* apply to all Ad Bocks in a Break independent of the type.

If Advertisements within a Break are not numbered the Ad Block Start *shall* comply with one of the following:

- sub_segment_num and sub_segments_expected *may* be omitted

OR

- sub_segments_expected on all Ad Block Starts *shall* be set to 0 (zero)
- sub_segment_num on all Ad Block Starts *shall* be set to 0 (zero)
- both sub_segment_num and sub_segments *shall* be present in the segmentation descriptor and included in the overall byte count for the segmentation descriptor

If Advertisement within a Break are numbered and contains only one Advertisement the Ad Bock Start *should* comply with the following:

- sub_segments_expected *shall* be set to 1 (one)
- sub_segment_num on the first Ad Block Start *shall* be set to 1 (one)

If the number of Advertisement within a Break increases from 1 (one) after the first Ad Block Start for the Break is sent, sub_segments_expected on the next Ad Block Start *shall* be updated with the new sub_segments_expected.

If Advertisements within a Break are numbered and there are multiple Ad Block Starts within a Break, the Ad Block Starts *shall* comply with the following:

- sub_segments_expected *shall* be set to the expected number of Advertisement within the Break.
- sub_segment_num on the Ad Bock Start *shall* be set to the relative position of the first underlying advertisement or promo within the Ad Block.

- The numbering of Advertisements and Promos **shall** comply with these constraints even if there are no segmentation message present for a given Advertisement or Promo.

If the number of Advertisements change, increase or decrease within the Break, sub_segments_expected on the next Ad Block Start **shall** be updated with the new sub_segments_expected. If the number of Advertisement is reduced after the last Ad Block Start is sent for a Break, the distributor implementation *should* recognize that no additional Advertisements will be signaled when the next Advertisement with sub_segment_num equal to 1 (one) is received, a Placement Opportunity End is received or a Break End is received.

10.3.3.14.4. Numbering of Advertisement and Promos

The numbering of Advertisements and Promos, Provider or Distributor, within a Break is dependent on whether:

- a) Advertisement and Promo numbering within a Break is not supported
- b) Advertisement and Promo numbering within a Break is supported

These constraints **shall** apply to all Advertisements and Promos in a Break independent of the type.

If Advertisements and Promos within a Break are not numbered the Advertisement Start **shall** comply with one of the following:

- sub_segment_num and sub_segments_expected *may* be omitted

OR

- sub_segments_expected on all starts **shall** be set to 0 (zero)
- sub_segment_num on all starts **shall** be set to 0 (zero)
- both sub_segment_num and sub_segments **shall** be present in the segmentation descriptor and included in the overall byte count for the segmentation descriptor

If Advertisement or Promo within a Break are numbered and contains only one Advertisement or Promo the Advertisement or Promo Start *should* comply with the following:

- sub_segments_expected **shall** be set to 1 (one)
- sub_segment_num on the first start **shall** be set to 1 (one)

If the number of Advertisements or Promos within a Break increases from 1 (one) after the first Advertisement or Promo Start for the Break is sent, sub_segments_expected on the next Advertisement or Promo Start **shall** be updated with the new sub_segments_expected.

If Advertisement and Promos within a Break are numbered and there are multiple Advertisement and Promo Starts within a Break, the Advertisement or Promo Starts **shall** comply with the following:

- sub_segments_expected **shall** be set to the expected number of Advertisements and Promos expected within the Break.
- sub_segment_num on the first Advertisement or Promo Start **shall** be set to 1 (one) and incremented by one on each subsequent Advertisement or Promo Start.
- The numbering of Advertisements and Promos **shall** comply with these constraints even if there are no segmentation message present for a given Advertisement or Promo.

If the number of Advertisements and Promos change, increase or decrease, within the Break, sub_segments_expected on the next Advertisement or Promo Start *shall* be updated with the new sub_segments_expected. If the number of Advertisement or Promos are reduced after the last Start is sent for a Break, the distributor implementation *should* recognize that no additional Advertisements will be signaled when the next Advertisement with sub_segment_num equal to 1 (one) is received, a Placement Opportunity End is received or a Break End is received.

10.3.3.15. Alternate Content Opportunities – Additional semantics

An Alternate Content Opportunity *shall* be introduced by a corresponding Start message and closed by an associated End message. In the scenario where one Alternate Content Opportunity is followed by another, the Alternate Content Opportunity End segmentation message from one and Alternate Content Opportunity Start segmentation in the next *may* reference the same PTS.

The Alternate Content Opportunity Start segmentation types and associated Alternate Content Opportunity End segmentation types *shall* have the same segmentation_event_id. See Section 10.3.3.7 for additional constraints on segmentation_event_id.

An Alternate Content Opportunity *may* contain one or more nested Alternate Content Opportunities. The Alternate Content Opportunity Start and associated Alternate Content Opportunity End for a contained Alternate Content Opportunity *shall* be within the Alternate Content Opportunity Start and first Alternate Content Opportunity End of the containing Alternate Content Opportunity.

10.3.3.15.1. Alternate Content Opportunity Identifiers

Each Alternate Content Opportunity Start and Alternate Content Opportunity End *shall* be uniquely identifiable by:

- Any appropriate segmentation_upid_type out of Table 22
- segmentation_upid set to a unique identifier

If Alternate Content Opportunity identifiers are present, associated Alternate Content Opportunity Start and End *shall* carry the same Alternate Content Opportunity identifiers. A given Alternate Content Opportunity identifier *shall* appear in one Alternate Content Opportunity Start and one Alternate Content Opportunity End.

10.3.3.15.2. Numbering of Alternate Content Opportunities

The numbering of Alternate Content Opportunities within a Program is dependent on whether:

- a) Alternate Content Opportunity numbering is not supported
- b) Alternate Content Opportunity numbering is supported

If Alternate Content Opportunities within a Program are not numbered, the Alternate Content Opportunity Start *shall* comply with one of the following:

- segments_expected *shall* be set to 0 (zero)
- segment_num on all Alternate Content Opportunity Starts *shall* be set to 0 (zero)

If Alternate Content Opportunities within a Program are numbered and contains only one opportunity, the Alternate Content Start *should* comply with the following:

- segments_expected *shall* be set to 1 (one)
- segment_num on the first Alternate Content Opportunity Start *shall* be set to 1 (one)

If the number of Alternate Content Opportunities within a Program increases from 1 (one) after the first Alternate Content Opportunity Start for the Program is sent, segments_expected on the next Alternate Content Opportunity Start *shall* be updated with the new segments_expected.

If Alternate Content Opportunities within a Program are numbered and there are multiple Alternate Content Opportunity Starts within a Program, the Alternate Content Opportunity Starts *shall* comply with the following:

- segments_expected *shall* be set to the expected number of Alternate Content Opportunity Start messages expected within the Program.
- segment_num on the first Alternate Content Opportunity Start *shall* be set to 1 (one) and incremented by one on each subsequent Alternate Content Opportunity Start.

If the number of Alternate Content Opportunities change, increase or decrease within the Program, segments_expected on the next Alternate Content Opportunity Start *shall* be updated with the new segments_expected. If the number of Alternate Content Opportunities is reduced after the last Alternate Content Opportunity Start is sent for a Program, the distributor implementation *should* recognize that no additional Alternate Content Opportunities will be signaled when the next Alternate Content Opportunity Start with segment_num equal to 1 (one) is received.

10.3.4. time_descriptor()

The time_descriptor is an implementation of a splice_descriptor. It provides an optional extension to the splice_insert(), splice_null() and time_signal() commands that allows a programmer's wall clock time to be sent to a client. For the highest accuracy, this descriptor *should* be used with a time_signal() or splice_insert() command that has the time_specified_flag equal to 1. This command *may* be inserted using SCTE 104 or by out of band provisioning on the device inserting this message.

The repetition rate of this descriptor *should* be at least once every 5 seconds. When it is the only descriptor present in the time_signal() or splice_null() command, then the encoder *should not* insert a key frame.

This command *may* be used to synchronize time based external metadata with video and the party responsible for the metadata and the time value used *should* ensure that they are properly synchronized and have the desired level of accuracy required for their application.

10.3.4.1. Informative description of TAI

The time_descriptor() uses the time format defined for the Precision Time Protocol [PTP]. [PTP] is based upon an international time scale called International Atomic Time (TAI), unlike NTP [RFC5905] which is based upon UTC. [PTP] is being used in a/v bridging and broadcast synchronization protocols and likely to be available in a studio environment. Other time sources, such as NTP or GPS, are readily convertible to PTP format.

TAI does not have "leap" seconds like UTC. When UTC was introduced (January 1, 1972) it was determined there *should* be a difference of 10 seconds between the two time scales. Since then an

additional 27 leap seconds (including one in December 2016) have been added to UTC to put the current difference between the two timescales at 37 seconds (as of June 2018) The [PTP] protocol communicates the current offset between TAI and UTC to enable conversion. By default [PTP] uses the same "epoch" (i.e. origination or reference start time and date of the timescale) as Unix time, of 00:00, January 1, 1970. Readers are advised to consult IERS Bulletin C for the current value of leap seconds [<https://www.iers.org/IERS/EN/Publications/Bulletins/bulletins.html>].

Table 27 - time_descriptor()

Syntax	Bits	Mnemonic
time_descriptor() {		
splice_descriptor_tag	8	uimsbf
descriptor_length	8	uimsbf
identifier	32	uimsbf
TAI_seconds	48	uimsbf
TAI_ns	32	uimsbf
UTC_offset	16	uimsbf
}		

The XML schema for the time_descriptor() is shown in Figure 21.

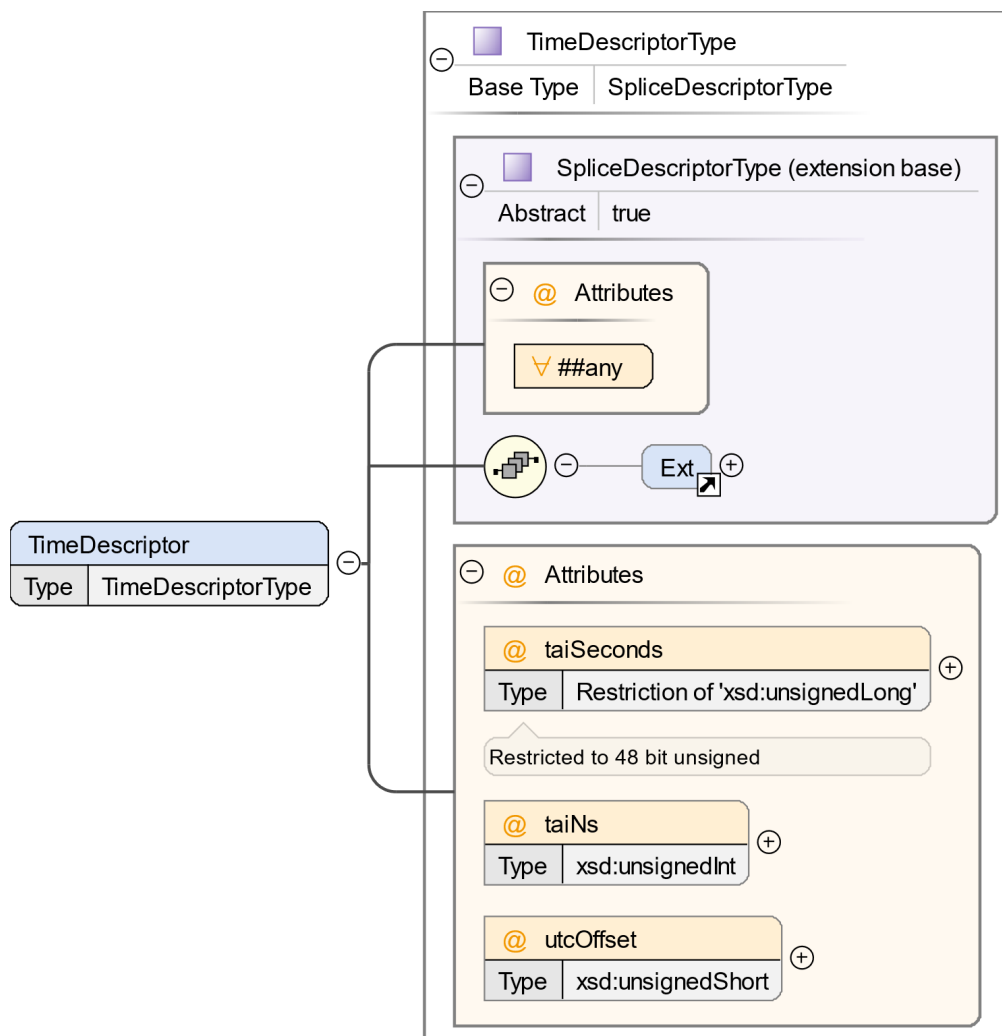

Figure 21 - TimeDescriptor

10.3.4.2. Semantic definition of fields in time_descriptor()

splice_descriptor_tag – This 8-bit number defines the syntax for the private bytes that make up the body of this descriptor. The splice_descriptor_tag *shall* have a value of 0x03.

There is no entry in the XML schema for splice_descriptor_tag. The value is set to 0x03 when transforming from an XML representation of the time_descriptor() to Bit Stream Format.

descriptor_length – This 8-bit number gives the length, in bytes, of the descriptor following this field. The descriptor_length field *shall* have a value of 0x10.

There is no entry in the XML schema for descriptor_length. The value *shall* be derived when converting an XML representation of the time_descriptor() to Bit Stream Format.

identifier – This 32-bit number is used to identify the owner of the descriptor. The identifier *shall* have a value of 0x43554549 (ASCII “CUEI”).

There is no entry in the XML schema for identifier.

TAI_seconds – This 48-bit number is the TAI seconds value.

@taiSeconds [Optional; xsd:unsignedLong] with a restriction up to 48 bits (281474976710656).

TAI_ns – This 32-bit number is the TAI nanoseconds value.

@taiNs [Optional; xsd:unsignedInt]

UTC_offset – This 16-bit number *shall* be used in the conversion from TAI time to UTC or NTP time per the following equations.

$$\text{UTC seconds} = \text{TAI seconds} - \text{UTC_offset}$$

$$\text{NTP seconds} = \text{TAI seconds} - \text{UTC_offset} + 2,208,988,800$$

@utcOffset [Optional; xsd:unsignedShort]

10.3.4.1. Synchronized Client Clock

The time_descriptor() provides a mechanism to associate a programmer's wall clock time with a presentation time in the media timeline as specified by the PTS carried in the splice_time structure of the command. The time_descriptor() *may* be used by a downstream device, such as a packager or set-top, to determine the offset to its local time-of-day clock with the incoming stream.

Figure 22 illustrates how the time-of-day SMPTE time code associated with a frame would be converted to TAI and associated with a presentation time stamp (PTS) value. The receiving equipment could then know the studio/origination time of any frame in the system by knowing the PTS to TAI offset. So, if the system inserts a time_descriptor every 5 seconds randomly and it happens to insert one on the second frame in the figure, a relationship is established with the PTS time of 711500 to a TAI of 14:12:38.0166. Now if a packager wants to insert an ID3 tag or cause a Segment Break and wants to name a file on the 08:12:01:21 SMPTE frame, it can take the current PTS of 740000 and subtract the 711500 value to get a 28500 difference in 90 kHz clock ticks and know that the wall clock time that has significance to the programmer was at 14:12:38.333 TAI.

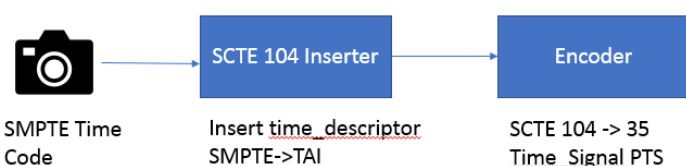
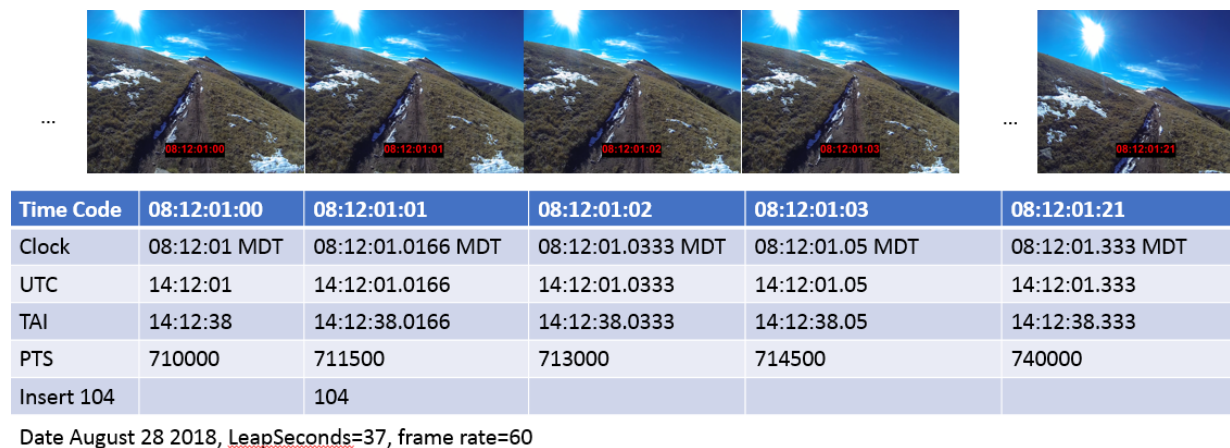

Figure 22 – Time Relationships

If stream processing results in a change in the time base, the splice_time, if present, *shall* either be rewritten or the pts_adjustment field *shall* carry the offset necessary to adjust the PTS carried in splice_time to the new time base so that the time_descriptor() maintains its accuracy.

If the value of a time_descriptor is carried into [DASH] or HLS media segments, the PTS value carried in splice_time, if present, *shall* be converted to the corresponding media time base and be carried as appropriate to the target format, for example an ‘emsg’ (or ‘prft’) structure in a [DASH] ISOBMFF media segment or an ID3 tag in an HLS media segment.

As the packets containing the time_descriptor() *may* not align with segment boundaries or other specific points in the delivery format, it may be necessary to derive new presentation and wall clock times from the time_descriptor() if that alignment is required. The packager or other stream processor is responsible for adjusting the presentation time and programmer’s wall clock time carried in the time_descriptor() appropriately.

An example would be to use this derived wall clock time to place a timestamp at the beginning of each media segment. One could use this timestamp, carried as a tag in the manifest file or in the media segments, to synchronize with external metadata.

10.3.4.2. Synchronized Clock carriage in HLS Timed Metadata (ID3 tags)

HLS defines a mechanism for carrying timed metadata as ID3 frames carried in PES packets, with associated PTS values. [HLS-TMD]

Two existing ID3 frames may be used to carry the contents of a time_descriptor, TDRL (release time) or TDEN (encoding time). Both of these carry a UTC timestamp in ISO 8601 format as described in the ID3v2 structure document [ID3v2-struct]. These timestamps provide a precision of seconds.

If finer precision is required the timestamp may be carried in an SCTE-defined private (PRIV) ID3 tag.

The format for PRIV frames per [ID3v2-struct] is:

```
Header          <"PRIV">
  Owner identifier <text string> $00
  The private data <binary data>
```

The owner identifier *shall* be <standards@scte.org>

The private data *shall* be <scte35-time\$00time> where “time” is an ISO 8601 timestamp with ms accuracy.

10.3.5. audio_descriptor()

The audio_descriptor() *should* be used when programmers and/or MVPDs do not support dynamic signaling (e.g., signaling of audio language changes) and with legacy audio formats that do not support dynamic signaling. As discussed in Section 9.1.5 of the SCTE Operational Practice on Multiple Audio Signaling [SCTE 248], since most MVPD head-ends do not change the PAT/PMT to signal changed audio streams, this descriptor in SCTE 35 should be used to signal such changes. This descriptor is an implementation of a splice_descriptor(). It provides the ability to dynamically signal the audios actually in use in the stream. This descriptor *shall* only be used with a time_signal command and a segmentation descriptor with the type Program_Start or Program_Overlap_Start.

Table 28 - audio_descriptor()

Syntax	Bits	Mnemonic
audio_descriptor() {		
splice_descriptor_tag	8	uimsbf
descriptor_length	8	uimsbf
identifier	32	uimsbf
audio_count	4	uimsbf
reserved	4	bslbf
for (i=0; i<audio_count; i++) {		
component_tag	8	uimsbf
ISO_code	24	uimsbf
Bit_Stream_Mode	3	uimsbf
Num_Channels	4	uimsbf
Full_Srvc_Audio	1	uimsbf
}		
}		

The XML schema for audio_descriptor() is shown in Figure 23.

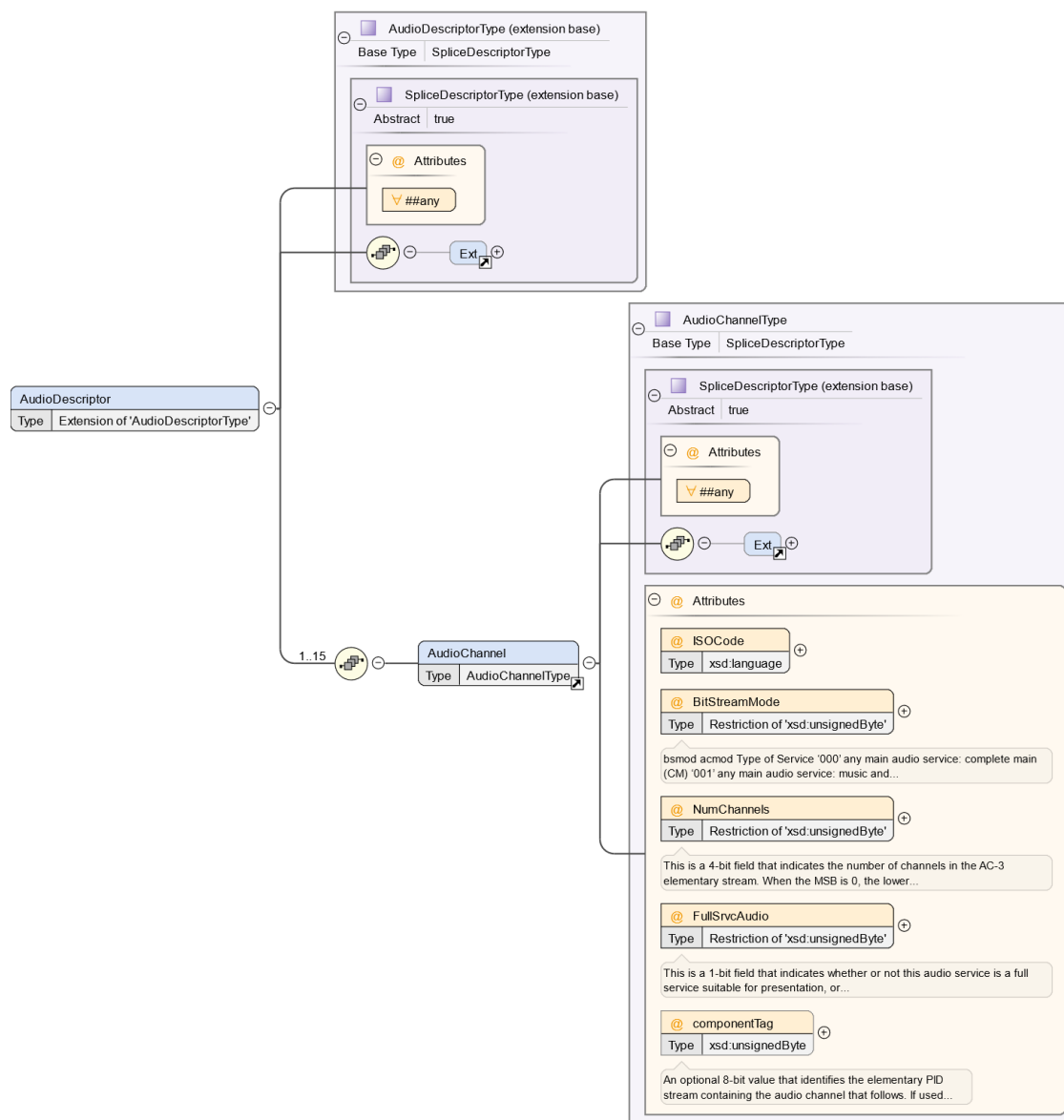

Figure 23 – AudioDescriptor

10.3.5.1. Semantic definition of fields in audio_descriptor()

splice_descriptor_tag – This 8-bit number defines the syntax for the private bytes that make up the body of this descriptor. The splice_descriptor_tag *shall* have a value of 0x04.

There is no entry in the XML schema for splice_descriptor_tag. The value is set to 0x04 when transforming from an XML representation of the audio_descriptor() to Bit Stream Format.

descriptor_length – This 8-bit number gives the length, in bytes, of the descriptor following this field.

There is no entry in the XML schema for descriptor_length. The value *shall* be derived when converting an XML representation of the audio_descriptor() to Bit Stream Format.

identifier – This 32-bit number is used to identify the owner of the descriptor. The identifier *shall* have a value of 0x43554549 (ASCII “CUEI”).

There is no entry in the XML schema for identifier.

audio_count – The value of this flag is the number of audio PIDs in the program.

There is no entry in the XML schema for audio_count. The value *shall* be derived when converting an XML representation of the audio_descriptor() to Bit Stream Format based on the number of audio channels.

component_tag – An optional 8-bit value that identifies the elementary PID stream containing the audio channel that follows. If used, the value *shall* be the same as the value used in the stream_identifier_descriptor() to identify that elementary PID stream. If this is not used, the value *shall* be 0xFF and the stream order *shall* be inferred from the PMT audio order.

@componentTag [Required, xsd:unsignedByte]

ISO_code – This field is a 3-byte language code defining the language of this audio service which *shall* correspond to a registered language code contained in the Code column of the [ISO 639-2] registry.

@chars [Optional; xsd:language]

Bit_Stream_Mode – As per ATSC A/52 Table 5.7.

@chars [Required, xsd:unsignedByte]

Num_Channels – As per ATSC A/52 Table A4.5.

@chars [Required, xsd:unsignedByte]

Full_Srvc_Audio – (From ATSC A/52 Annex A.4.3)

“This is a 1-bit field that indicates if this audio service is a full service suitable for presentation, or a partial service which should be combined with another audio service before presentation. This bit *should* be set to a ‘1’ if this audio service is sufficiently complete to be presented to the listener without being combined with another audio service (for example, a visually impaired service which contains all elements of the Program; music, effects, dialogue, and the visual content descriptive narrative). This bit *should* be set to a ‘0’ if the service is not sufficiently complete to be presented without being combined with another audio service (e.g., a visually impaired service which only contains a narrative description of the visual Program content and which needs to be combined with another audio service which contains music, effects, and dialogue).”

@chars [Required, xsd:unsignedByte]

11. Encryption

11.1. Overview

The splice_info_section supports the encryption of a portion of the section in order that one *may* prevent access to an avail to all except those receivers that are authorized for that avail. This section of the document describes the various encryption algorithms that *may* be used. The encryption of the section is optional, as is the implementation of encryption by either the creator of the message, or any receive

devices. The use of encryption is deemed optional to allow a manufacturer to ship “in-the-clear” systems without worrying about the export of encryption technology. If encryption is included in the system, any receive device *shall* implement all of the algorithms listed in this document, which allows the creator of a splice info table to use any of the algorithms in a transmission. The use of private encryption technology is optional, and out of the scope of this document.

11.2. Fixed key encryption

The encryption used with this document assumes a fixed key is to be used. The same key is provided to both the transmitter and the receiver. The method of delivering the key to all parties is unspecified. This document allows for up to 256 different keys to be available for decryption. The `cw_index` field is used to determine which key *should* be used when decrypting a section. The length of the fixed key is dependent on the type of algorithm being used. It is assumed that fixed key delivered to all parties will be the correct length for the algorithm that is intended to be used.

11.3. Encryption algorithms

NOTE: FIPS Publication 46-3 was withdrawn on May 19, 2005 and implementers that require encryption of SCTE 35 messages *may* wish to use a user private encryption algorithm.

The `encryption_algorithm` field of the `splice_info_section` is a 6-bit value, which *may* contain one of the values shown in Table 29. All Data Encryption Standard variants use a 64-bit key (actually 56 bits plus a checksum) to encrypt or decrypt a block of 8 bytes. In the case of triple DES, there will need to be 3 64-bit keys, one for each of the three passes of the DES algorithm. The “standard” triple DES actually uses two keys, where the first and third keys are identical. See [FIPS PUB 46-3] and [FIPS PUB 81].

Table 29 - Encryption algorithm

Value	Encryption algorithm
0	No encryption
1	DES – ECB mode
2	DES – CBC mode
3	Triple DES EDE3 – ECB mode
4-31	Reserved
32-63	User private

11.3.1. DES – ECB mode

This algorithm uses the “Data Encryption Standard”, (see [FIPS PUB 81]), in the electronic codebook mode.

In order to use this type of encryption, the encrypted data *shall* contain a multiple of 8 bytes of data, from `splice_command_type` through to `E_CRC_32` fields. The `alignment_stuffing` loop *may* be used to pad any extra bytes that *may* be required.

11.3.2. DES – CBC mode

This algorithm uses the “Data Encryption Standard” (see [FIPS PUB 81]), in the cipher block chaining mode. The basic algorithm is identical to DES ECB. Each 64-bit plaintext block is bitwise exclusive-ORed with the previous ciphertext block before being encrypted with the DES key. The first block is exclusive-ORed with an initial vector. For the purposes of this document, the initial vector *shall* have a fixed value of zero.

In order to use this type of encryption, the encrypted data *shall* contain a multiple of 8 bytes of data, from splice_command_type through to E_CRC_32 fields. The alignment_stuffing loop *may* be used to pad any extra bytes that *may* be required.

11.3.3. Triple DES EDE3 – ECB mode

This algorithm uses three 64-bit keys, each key being used on one pass of the DES-ECB algorithm (see [FIPS PUB 46-3]). Every block of data at the transmit device is first encrypted with the first key, decrypted with the second key, and finally encrypted with the third key. Every block at the receive site is first decrypted with the third key, encrypted with the second key, and finally decrypted with the first key.

In order to use this type of encryption, the encrypted data *shall* contain a multiple of 8 bytes of data, from splice_command_type through to E_CRC_32 fields. The alignment_stuffing loop *may* be used to pad any extra bytes that *may* be required.

11.3.4. User private algorithms

This document allows for the use of private encryption algorithms. It is not specified how the transmit and receive devices agree on the algorithm to use for any user private code. It is also not specified as to how coordination of private values for the encryption_algorithm field *should* be registered or administered.

12. SCTE 35 Usage

When SCTE 35 messages are carried in containers other than MPEG Transport Streams, the identifiers in the table below are defined in the SCTE URN namespace and may be used to identify the presence and formatting of SCTE 35 messages.

The details of how these identifiers are used are specific to the delivery format and will be defined in the delivery format specifications, e.g. DASH-specific requirements are defined in [SCTE 214-1].

Identifier	Format of SCTE 35 messages
urn:scte:scte35:2013:xml	an XML representation of an SCTE 35 message containing either a Signal.SpliceInfoSection element or a Signal.Binary element as defined in Section 7 of this specification.
urn:scte:scte35:2014:xml+bin	an XML representation of an SCTE 35 message containing only a Signal.Binary element as defined in Section 7.4 of this specification
urn:scte:scte35:2013:bin	A binary copy of an entire SCTE 35 splice_info_section starting at the table_id and ending with the CRC_32

12.1. SCTE 35 Usage in DASH

SCTE 35 messages can be carried in DASH. See [SCTE 214-1].

12.2. SCTE 35 Usage in HLS

Manipulation of an HLS m3u8 manifest is used to provide seamless ad insertion. The manifest is modified to include targeted ads prior to delivery to the player or the manifest is modified at the player before delivery to the device’s video playback engine. These mechanisms allow for seamless playback

without buffering or other interruptions in the playback experience. HLS m3u8 manifest manipulation can be done on a server or on a client (for example, to implement companion ads). Client-side ad insertion typically would need a secure player implementation to ensure the ad segments play out correctly.

This document presents two alternatives for SCTE 35 messages that are carried in HLS. The recommended approach is based on [HLS-TMD] and is clarified in Section 12.2.1. The legacy approach is specified in Section 12.2.2. Both methods can be used in the same manifest and it is up to the implementer to use the appropriate markings for the devices and players that they require compatibility with.

12.2.1. SCTE 35 markup in HLS using EXT-X-DATERANGE

Carriage of SCTE 35 in HLS using EXT-X-DATERANGE is described in [HLS-TMD].

For clarification, when using the END-ON-NEXT attribute, the CLASS attribute *should* be set to the segmentation_type_id value of the associated splice out cue. This ensures that sequential cues of the same time can be labeled by the same CLASS.

12.2.2. SCTE 35 markup in HLS using EXT-X-SCTE35

Ad cues and other signaling metadata are placed into the HLS m3u8 manifest file using HLS tags and attribute lists.

The SCTE 35 HLS tag definition in this standard is consistent with HLS tag definitions in [HLS].

The SCTE 35 HLS attributes on the tag definition in this standard is consistent with HLS attribute definition in [HLS].

The SCTE 35 HLS attributes *shall* comply with the following:

Attribute Type	AttributeValue Data Type
Number	decimal-floating-point
String	quoted-string

The general method of operation utilizes tags marking the beginning and end of each signaled sequence of content Segments. In this way it is possible to signal Placement Opportunities, local (distributor) avails and Provider Advertisements.

Using tags marking the beginning and end of each signaled sequence of content Segments *may* also be used to control stream blackouts using manifest manipulation on the server, so restricted content is never sent to the viewer.

12.2.3. HLS cue tags

The #EXT-X-SCTE35 is the only tag defined by this standard.

Table 30 - Tag #EXT-X-SCTE35

Tag Name	Attributes	Description
#EXT-X-SCTE35	CUE DURATION ELAPSED ID TIME TYPE UPID BLACKOUT CUE-OUT CUE-IN SEGNE	Tag representing an embedded SCT35 message as a binary representation as described in Section 7.4 The binary representation <i>shall</i> be encoded in Base64 as defined in Section 7.4 of [RFC 4648] with W3C recommendations. The client or manifest manipulator <i>should</i> decode the Base64 encoded string, then apply Table 5 to interpret the message.

Table 31 - Tag attributes

Attribute Name	Attribute Type	Required	Description
CUE	String	Required	The SCTE 35 binary message encoded in Base64 as defined in Section 7.4 of [RFC 4648] with W3C recommendations.
DURATION	Double	Optional	The duration of the signaled sequence defined by the CUE. The duration is expressed in seconds to millisecond accuracy.
ELAPSED	Double	Optional	Offset from the CUE (typically a start segmentation type) of the earliest presentation time of the HLS media segment that follows. If an implementation removes fragments from the manifest file (e.g., live application), the ELAPSED value <i>shall</i> be adjusted by the duration of the media segments removed. Elapsed is expressed in seconds to millisecond accuracy.
ID	String	Optional	A unique value identifying the CUE.
TIME	Double	Optional	TIME represents the start time of the signaled sequence. If present in a stream, the SCTE 35 time descriptor <i>should</i> be utilized as the time basis. Since time descriptor uses TAI, a conversion to UTC is required (see Section 10.3.4.2). TIME <i>shall</i> be the UTC time corresponding to the start time of the first inserted HLS media segment. TIME <i>shall</i> be to millisecond accuracy. To calculate the actual temporal position within the content for the CUE, add TIME and ELAPSED.
TYPE	Integer	Optional	If present, the segmentation_type_id from the SCTE 35 segmentation descriptor. (See Table 23, NOTE: An Integer <i>may</i> be expressed as a decimal or in other bases such as hexadecimal.

Attribute Name	Attribute Type	Required	Description
			When hex representation is used the value <i>should</i> be preceded by 0x)
UPID	String	Optional	Quoted string containing the segmentation_upid_type and the segmentation_upid separated by a colon. The segmentation_upid_type is an ascii hex value prefixed with 0x or 0X. The segmentation_upid is an ascii hex prefixed with 0x or 0X, or an ascii string representation of the decoded binary. If segmentation_upid_type is 0x0D (MID), separate each <segmentation_upid_type:segmentation_upid> pair with a semi-colon.
BLACKOUT	String	Optional	Enumeration of delivery restriction states as determined by business logic in the packager. Valid values are: YES, NO (default), MAYBE. YES indicates content is currently subject to blackout. MAYBE indicates content is subject to conditional restrictions and that external authorization is required for rights enforcement (i.e., regional blackout and/or device restrictions). NO indicates content is not subject to restriction.
CUE-OUT	String	Optional	Signal to begin ad insertion. Valid values are: YES, NO (default), CONT. CONT signals the "continuation" of a Break replacement opportunity started with CUE-OUT on a previous tag. Used for partial Break replacement when a player joins mid-Break. When CONT is present, the ELAPSED and DURATION attributes should be included.
CUE-IN	String	Optional	Signal to stop replacing content. Valid values are: YES, NO (default)
SEGNE	String	Optional	Values from the segment_num and segment_expected fields, expressed as decimal integers and delimited with a colon. For example, SEGNE="3:3"

12.2.4. HLS playlist example

The following HLS example illustrates a possible live programming scenario that includes a full complement of #EXT-X-SCTE 35 tags.

1. Network Start (0x50) – 2015-12-01T00:00:00+00:00 – 32400.0 seconds of elapsed video removed from the playlist since original tag at 1448928000.000.
2. Program Start (0x10) – 2015-12-01T09:00:00+00:00 – Blackout attribute indicates a potential regional blackout.
3. Provider Placement Opportunity Start (0x34) – Duration 60.060 seconds – Cue-Out indicates dynamic ad insertion/replacement is desired by the publisher.

SCTE 35 2023r1

- a. Distributor Placement Opportunity Start (0x36).
- b. Distributor Placement Opportunity End (0x37).
4. Provider Placement Opportunity End (0x35).
5. Program End (0x11) and Program Start (0x10) for the next Program, which is not subject to blackout restrictions.

The SCTE35 Base64 CUE values have been omitted for the sake of space and clarity of the example.

```
#EXTM3U
#EXT-X-TARGETDURATION:10
#EXT-X-VERSION:4
#EXT-X-MEDIA-SEQUENCE:918
#EXT-X-PROGRAM-DATE-TIME:2015-12-01T09:00:00+00:00
#EXT-X-SCTE35:TYPE=0x50,TIME=1448928000.000,ELAPSED=32400.0,CUE="...",ID="e+CuqI"
#EXT-X-SCTE35:TYPE=0x10,ELAPSED=0.0,UPID="0x08:0x9425",BLACKOUT=MAYBE,CUE="...",ID="dAQ"
#EXTINF:1.034
stream_med_00000.ts
#EXTINF:10.010
stream_med_00001.ts
#EXTINF:10.010
stream_med_00002.ts
#EXTINF:10.010
stream_med_00003.ts
#EXT-X-SCTE35:TYPE=0x34,DURATION=60.060,CUE-OUT=YES,UPID="0x08:0x9425BC",CUE="...",ID="f6UrRd"
#EXTINF:10.010
stream_med_00004.ts
#EXTINF:10.010
stream_med_00005.ts
#EXT-X-SCTE35:TYPE=0x36,CUE="...",ID="4Y1v5d"
#EXTINF:10.010
stream_med_00006.ts
#EXTINF:10.010
stream_med_00007.ts
#EXTINF:10.010
stream_med_00008.ts
#EXT-X-SCTE35:TYPE=0x37,CUE="...",ID="pIViS5"
#EXTINF:10.010
stream_med_00009.ts
#EXT-X-SCTE35:TYPE=0x35,CUE-IN=YES,CUE="...",ID="f6UrRd"
#EXTINF:10.010
stream_med_00010.ts
#EXTINF:10.010
stream_med_00011.ts
#EXTINF:10.010
stream_med_00012.ts
#EXT-X-SCTE35:TYPE=0x11,UPID="0x08:0x9425BC",CUE="...",ID="dAQpTQ"
#EXT-X-SCTE35:TYPE=0x10,UPID="0x08:0x9425BD",BLACKOUT=NO,CUE="...",ID="dAQpTr"
#EXTINF:10.010
stream_med_00013.ts
```

13. SCTE 35 XML elements and types

In addition to the SCTE 35 XML types and associated elements and attributes described in earlier sections of this specification, this section provides details on additional SCTE 35 XML elements and types.

13.1. Ext element

The Ext (extensibility) element allows zero or more elements from any namespace to be included. This element facilitates expansion, customization, and extensibility of the specification. Encapsulating elements from external namespaces into a single element allows filters, transforms, and other operations to be applied easily. See Figure 24.

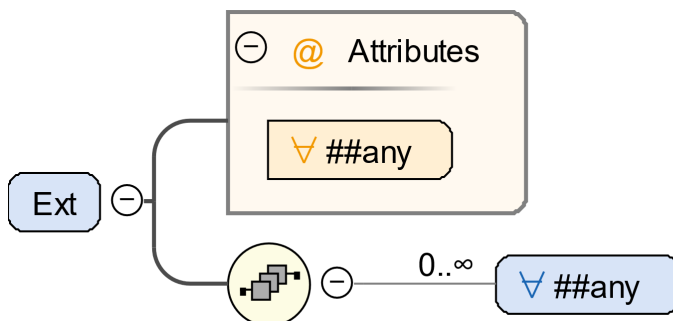

Figure 24 - Ext Element

@##any [Optional] – Any additional attribute from any namespace.

##any[Optional] – Zero or more elements from any namespace. (Zero elements are allowed as all the data *may* be included via attributes.)

13.2. PTSType

PTSType is a simple type used to specify a PTS Time. PTSType is an xsd:unsignedLong that can hold 33-bit time. It is constrained to a minimum value of 0 and a maximum value of 8589934592. The default value is 0.

13.3. Segmentation Upid Element

The Segmentation Upid Element is used to express a UPID in an XML document. See 10.3.3 segmentation_descriptor() for usage in a segmentation descriptor.

The XML schema for SegmentationUpid is shown in Figure 25.

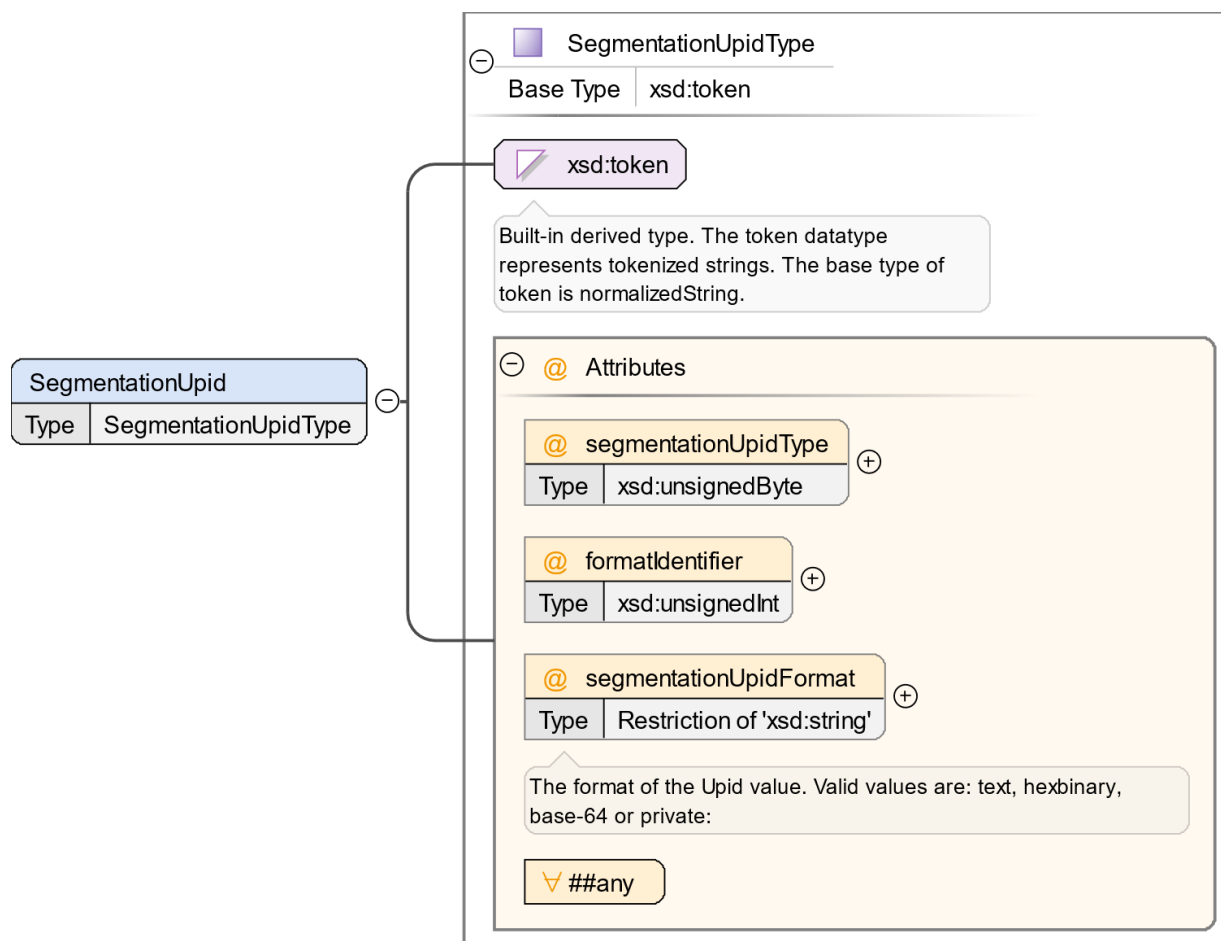

Figure 25 - SegmentationUpid

`@segmentationUpidType` [Optional, `xsd:unsignedByte`]. See Table 22 for valid values. The value for `MID()` *shall not* be specified. `MID()` *shall* be implied based on the presence of multiple `SegmentationUpid` Elements.

`@formatIdentifier` [Optional, `xsd:unsignedInt`]. Specify for MPU only. See Section 10.3.3.3 for description of `format_identifier` in an MPU.

`@segmentationUpidFormat`. The format of the UPID value. Valid values are: `text`, `hexBinary`, `base-64` or `private`.

14. Sample SCTE 35 Messages (Informative)

These are examples. In actual practice, there would be many variations of options and their use. These examples are meant to provide an overview and insight into the use and capabilities of Messages within this standard.

The decoding of the hex/base64 strings omits some redundant information such as the CUEI identifier for clarity. These examples are the output from the open source decoder available on github.

14.1. time_signal – Placement Opportunity Start

This is an example of using the time_signal command with a segmentation descriptor. The programmer that created this message used the Web Delivery Allowed flag to indicate the broadcast Advertisements should be blacked out. This would tend to also indicate that digital ad insertion would be used to insert new Advertisements in their place. The programmer is also using the Segment number in a non-normative manner to indicate that there are Distributor Placement Opportunities within this Provider Placement Opportunity. A standardized method of doing this would be to use the MID format of the segmentation UPID type and insert a UPID type 0x0E (ADS) with this information.

Also note the Tier value in this message is 0xffff as displayed on the output of a receiver. It is likely that the value of Tier in transmission had a different value that this receiver was authorized to receive, and the receiver obfuscated that by changing the value to 0xffff.

2018-07-16 00:04:57 M274P29528596539

Hex=0xFC30340000000000FFFF0506FE72BD0050001E021C435545494800008E7FCF0001A599B0080800000002CA0A18A3402009AC9D17E

Base64=/DA0AAAAAAAA//wBQb+cr0AUAAeAhxDVUVJSAAAJn/PAAGImbAICAAAAAsoKGKNAlAmsnRfg==

Decoded length = 55

Table ID = 0xFC

MPEG Short Section

Not Private

Reserved = 0x3

Section Length = 52

Protocol Version = 0

unencrypted Packet

PTS Adjustment = 0x00000000

Tier = 0xffff

Splice Command Length = 0x5

Time Signal

Time = 0x072bd0050 - 21388.766756

Descriptor Loop Length = 30

Segmentation Descriptor - Length=28

Segmentation Event ID = 0x4800008e

Segmentation Event Cancel Indicator NOT set

Delivery Not Restricted flag = 0

Web Delivery Allowed flag = 0

SCTE 35 2023r1

No Regional Blackout flag = 1

Archive Allowed flag = 1

Device Restrictions = 3

Program Segmentation flag SET

Segmentation Duration = 0x0001a599b0 = 307.000000 seconds

UPID Type = Turner Identifier length = 8

Turner Identifier = 0x000000002ca0a18a

Type = Placement Opportunity Start

Segment num = 2 Segments Expected = 0

CRC32 = 0x9ac9d17e

14.2. splice_insert

This is the legacy standard for a Distributor Placement Opportunity. As a significant number of existing ad servers will not respond to the newer time_signal command, it is likely that this message will be in use until the legacy components are removed and replaced. The programmer that generated this message uses the Break duration and auto return mode for the splice_insert. The Break duration at 60.293567 seconds is slightly longer than the contracted 60 second local avail; it is, however, the exact duration of the content that the local avail will overlay. This means that the encoder will generate a key frame at that specified Break duration from the splice time and the affiliate should fill the duration with a slate or black (in some countries a blue color is used). Some splicers or fragmented file delivery systems may be able to adjust the duration and boundaries to match the key frames as well.

2018-07-16 00:06:59 M274P29540838841

Hex=0xFC302F000000000000FFFFF014054800008F7FEFF7369C02EFE0052CCF50000000000A0008435545490000013562DBA30A

Base64=/DAvAAAAAAAA//wFAVIAACPf+/+c2nALv4AUsz1AAAAAAAAKAhDVUVJAAABNWLbowo=

Decoded length = 50

Table ID = 0xFC

MPEG Short Section

Not Private

Reserved = 0x3

Section Length = 47

Protocol Version = 0

unencrypted Packet

PTS Adjustment = 0x00000000

Tier = 0xff

SCTE 35 2023r1

Splice Command Length = 0x14

Splice Insert

Splice Event ID = 0x4800008f

Flags OON=1 Prog=1 Duration=1 Immediate=0

Splice time = 0x07369c02e - 21514.559089

Auto Return

break duration = 0x00052ccf5 = 60.293567 seconds

Unique Program ID = 0

Avail Num = 0

Avails Expected = 0

Descriptor Loop Length = 10

Avail Descriptor - Length=8

Avail Descriptor = 0x00000135 - 309

CRC32 = 0x62dba30a

14.3. time_signal – Placement Opportunity End

2018-07-16 00:10:04 M274P29559224252

Hex=0xFC302F00000000000000FFFF00506FE746290A000190217435545494800008E7F9F0808000000002CA0A18A350200A9CC6758

Base64=/DAvAAAAAAAAA//wBQb+dGKQoAAZAhDVUVJSAAAJn+fCAgAAAAALKChijUCAKnMZ1g=

Decoded length = 50

Table ID = 0xFC

MPEG Short Section

Not Private

Reserved = 0x3

Section Length = 47

Protocol Version = 0

unencrypted Packet

PTS Adjustment = 0x00000000

Tier = 0xff

Splice Command Length = 0x5

Time Signal

Time = 0x0746290a0 - 21695.740089

SCTE 35 2023r1

Descriptor Loop Length = 25

Segmentation Descriptor - Length=23

Segmentation Event ID = 0x4800008e

Segmentation Event Cancel Indicator NOT set

Delivery Not Restricted flag = 0

Web Delivery Allowed flag = 1

No Regional Blackout flag = 1

Archive Allowed flag = 1

Device Restrictions = 3

Program Segmentation flag SET

UPID Type = Turner Identifier length = 8

Turner Identifier = 0x00000002ca0a18a

Type = Placement Opportunity End

Segment num = 2 Segments Expected = 0

CRC32 = 0xa9cc6758

14.4. time_signal – Program Start/End

2018-07-16 00:00:15 M274P29500484335

Hex=0xFC30480000000000FFFFF00506FE7A4D88B60032021743554549480000187F9F0808000000002CCBC344110000021743554549480000197F9F0808000000002CA4DBA01000009972E343

Base64=//DBIAAAAAAAAA//wBQb+ek2ltgAyAhdDVUVJSAAGH+fCAgAAAAALMvDRBEAAAIxQ1VFSUgAABI/nwgIAAAACyk26AQAACZcuND

Decoded length = 75

Table ID = 0xFC

MPEG Short Section

Not Private

Reserved = 0x3

Section Length = 72

Protocol Version = 0

unencrypted Packet

PTS Adjustment = 0x00000000

Tier = 0xff

Splice Command Length = 0x5

Time Signal

SCTE 35 2023r1

Time = 0x07a4d88b6 - 22798.906911

Descriptor Loop Length = 50

Segmentation Descriptor - Length=23

Segmentation Event ID = 0x48000018

Segmentation Event Cancel Indicator NOT set

Delivery Not Restricted flag = 0

Web Delivery Allowed flag = 1

No Regional Blackout flag = 1

Archive Allowed flag = 1

Device Restrictions = 3

Program Segmentation flag SET

UPID Type = Turner Identifier length = 8

Turner Identifier = 0x000000002ccb344

Type = Program End

Segment num = 0 Segments Expected = 0

Segmentation Descriptor - Length=23

Segmentation Event ID = 0x48000019

Segmentation Event Cancel Indicator NOT set

Delivery Not Restricted flag = 0

Web Delivery Allowed flag = 1

No Regional Blackout flag = 1

Archive Allowed flag = 1

Device Restrictions = 3

Program Segmentation flag SET

UPID Type = Turner Identifier length = 8

Turner Identifier = 0x000000002ca4dba0

Type = Program Start

Segment num = 0 Segments Expected = 0

CRC32 = 0x9972e343

14.5. time_signal – Program Overlap Start

2018-07-16 02:59:52 M274P30575324060

Hex=0xFC302F0000000000FFFF00506FEAEBFF640019021743554549480000087F9F080800000002CA56CF5170000951DB0A8

SCTE 35 2023r1

Base64=/DAvAAAAAAAAA//wBQb+rr//ZAAZAhDVUVJSAAACH+fCAgAAAAALKVs9RcAAJUdsKg=

Decoded length = 50

Table ID = 0xFC

MPEG Short Section

Not Private

Reserved = 0x3

Section Length = 47

Protocol Version = 0

unencrypted Packet

PTS Adjustment = 0x00000000

Tier = 0xff

Splice Command Length = 0x5

Time Signal

Time = 0x0aebfff64 - 32575.759333

Descriptor Loop Length = 25

Segmentation Descriptor - Length=23

Segmentation Event ID = 0x48000008

Segmentation Event Cancel Indicator NOT set

Delivery Not Restricted flag = 0

Web Delivery Allowed flag = 1

No Regional Blackout flag = 1

Archive Allowed flag = 1

Device Restrictions = 3

Program Segmentation flag SET

UPID Type = Turner Identifier length = 8

Turner Identifier = 0x00000002ca56cf5

Type = Program Overlap Start

Segment num = 0 Segments Expected = 0

CRC32 = 0x951db0a8

14.6. time_signal – Program Blackout Override / Program End

Since the restriction flags are not evaluated on an End message, the use of the Program blackout override can be used in the case of an overlap start or other condition where the restrictions may need to be changed during a Program playback.

2018-07-16 01:45:45 M274P30131806863

Hex=0xFC30480000000000FFFF00506FE932E380B00320217435545494800000A7F9F080800000002CA0A1E3180000021743554549480000097F9F080800000002CA0A18A110000B4217EB0

Base64=/DBIAAAAAAAAA//wBQb+ky44CwAyAhdDVUVJSAACn+fCAgAAAAALKCh4xgAAIXQ1VFSUgAAAI/nwgIAAAACygoYoRAAC0IX6w

Decoded length = 75

Table ID = 0xFC

MPEG Short Section

Not Private

Reserved = 0x3

Section Length = 72

Protocol Version = 0

unencrypted Packet

PTS Adjustment = 0x00000000

Tier = 0xff

Splice Command Length = 0x5

Time Signal

Time = 0x0932e380b - 27436.441722

Descriptor Loop Length = 50

Segmentation Descriptor - Length=23

Segmentation Event ID = 0x4800000a

Segmentation Event Cancel Indicator NOT set

Delivery Not Restricted flag = 0

Web Delivery Allowed flag = 1

No Regional Blackout flag = 1

Archive Allowed flag = 1

Device Restrictions = 3

Program Segmentation flag SET

SCTE 35 2023r1

Not Private

Reserved = 0x3

Section Length = 97

Protocol Version = 0

unencrypted Packet

PTS Adjustment = 0x00000000

Tier = 0xff

Splice Command Length = 0x5

Time Signal

Time = 0x0a8cd44ed - 31466.942367

Descriptor Loop Length = 75

Segmentation Descriptor - Length=23

Segmentation Event ID = 0x480000ad

Segmentation Event Cancel Indicator NOT set

Delivery Not Restricted flag = 0

Web Delivery Allowed flag = 1

No Regional Blackout flag = 1

Archive Allowed flag = 1

Device Restrictions = 3

Program Segmentation flag SET

UPID Type = Turner Identifier length = 8

Turner Identifier = 0x000000002cb2d79d

Type = Placement Opportunity End

Segment num = 2 Segments Expected = 0

Segmentation Descriptor - Length=23

Segmentation Event ID = 0x48000026

Segmentation Event Cancel Indicator NOT set

Delivery Not Restricted flag = 0

Web Delivery Allowed flag = 1

No Regional Blackout flag = 1

Archive Allowed flag = 1

Device Restrictions = 3

SCTE 35 2023r1

Program Segmentation flag SET

UPID Type = Turner Identifier length = 8

Turner Identifier = 0x000000002cb2d79d

Type = Program End

Segment num = 0 Segments Expected = 0

Segmentation Descriptor - Length=23

Segmentation Event ID = 0x48000027

Segmentation Event Cancel Indicator NOT set

Delivery Not Restricted flag = 0

Web Delivery Allowed flag = 1

No Regional Blackout flag = 1

Archive Allowed flag = 1

Device Restrictions = 3

Program Segmentation flag SET

UPID Type = Turner Identifier length = 8

Turner Identifier = 0x000000002cb2d7b3

Type = Program Start

Segment num = 0 Segments Expected = 0

CRC32 = 0x8a18869f